



**IT- og Telestyrelsen**

Ministeriet for Videnskab  
Teknologi og Udvikling

# OIOUBL Guideline

OIOUBL Statement

UBL 2.0 Statement

G15

Version 1.1



This release is protected by Creative Commons License, Naming 2.5 

# Colophon

**Contact:**

National IT and Telecom Agency

E-mail: [oioubl@itst.dk](mailto:oioubl@itst.dk)

:

**April 2007**  
**Ministry of Science, Technology and Innovation**  
**National IT and Telecom Agency**

Data Standardization Office  
Holsteinsgade 63  
DK-2100 Copenhagen Ø  
Phone +45 3545 0000  
Fax +45 3545 0010  
<http://www.itst.dk>  
[itst@itst.dk](mailto:itst@itst.dk)

Copyrights for this release in accordance with Creative Common, Naming 2.5:

**Permission is granted to:**

- *produce processed works based on this document*
- *reproduce and make the document available to the public*
- *use the document for commercial purposes*  
*provided that the Danish National IT & Telecom Agency be clearly referenced as the source of this release.*

Further information about these rights is available at <http://creativecommons.org/licenses/by/2.5/deed.da>.

# Contents

<b>1. How to read this document.....</b>	<b>4</b>
1.1 Structure of this document.....	4
1.2 Figure definitions .....	4
1.3 Term definitions .....	5
1.4 References.....	6
<b>2. How to fill in OIOUBL document instances.....</b>	<b>7</b>
2.1 Namespace.....	7
2.2 Comments.....	7
2.3 Process instructions.....	8
2.4 Relations to instances of other customizations.....	8
2.5 Code example.....	8
<b>3. Statement.....</b>	<b>9</b>
3.1. Statement.....	10
3.2. Statement.AccountingSupplierParty.....	17
3.2.1. Statement.AccountingSupplierParty.Party.....	19
3.3. Statement.AccountingCustomerParty.....	23
3.3.1. Statement.AccountingCustomerParty.Party.....	25
3.3.1.1. Statement.AccountingCustomerParty.Party.Contact.....	29
3.4. Statement.BuyerCustomerParty.....	31
3.4.1. Statement.BuyerCustomerParty.Party.....	33
3.5. Statement.SellerSupplierParty.....	37
3.5.1. Statement.SellerSupplierParty.Party.....	39
3.6. Statement.PayeeParty.....	43
3.7. Statement.AllowanceCharge.....	46
3.8. Statement.StatementLine.....	50
3.8.1. Statement.StatementLine.BillingReference.....	55
3.8.1.1. Statement.StatementLine.BillingReference.InvoiceDocumentReference.....	57
3.8.1.1.1. Statement.StatementLine.BillingReference.InvoiceDocumentReference.Attachment.....	59
3.8.1.2. Statement.StatementLine.BillingReference.SelfBilledInvoiceDocumentReference.....	61
3.8.1.2.1. Statement.StatementLine.BillingReference.SelfBilledInvoiceDocumentReference.Attachment.....	63
3.8.1.3. Statement.StatementLine.BillingReference.CreditNoteDocumentReference.....	65
3.8.1.3.1. Statement.StatementLine.BillingReference.CreditNoteDocumentReference.Attachment.....	67
3.8.1.4. Statement.StatementLine.BillingReference.SelfBilledCreditNoteDocumentReference.....	69
3.8.1.4.1. Statement.StatementLine.BillingReference.SelfBilledCreditNoteDocumentReference.Attachment.....	71
3.8.1.5. Statement.StatementLine.BillingReference.ReminderDocumentReference.....	73
3.8.1.5.1. Statement.StatementLine.BillingReference.ReminderDocumentReference.Attachment.....	75

## 1. How to read this document

This guideline covers the use of an invoice in OIOUBL. The guideline must be read in correlation with the remaining documents included in the OIOUBL package.

### 1.1 Structure of this document

This document should be seen as the normative description of an invoice. In case of any conflict, the most specific description will always apply. For example, the description on the lines of a specific element takes precedence of the description at document level. Hence, the descriptions at document level are default values for the lines. The examples in this document and related common guidelines should be seen as descriptive. The guideline text takes precedence of the figures.

The document includes a reading instruction, a description of how to fill in document instances, as well as the actual class specification. The actual specification is composed of:

- A figure showing the class elements that are included in OIOUBL.
- A text specification of the class.
- A list of the UBL elements that from a business perspective make no sense in the specific context.
- A list of the fields that are included in the class.
- A list of the sub-classes that are included in the class.
- A table of key data such as definitions, names, references, and business rules for each of the class fields.
- A table of key data such as definitions, names, references, and business rules for the sub-classes of the class.
- For each of the sub-classes that is used differently that described in the class library, OIOUBL\_GUIDE\_LIBRARY (ref 30), a subsection contains a corresponding specification. Hence, the sub-classes that have been included in the specification are not selected based on relevance, but solely based on whether they deviate from the general definition of the library.

### 1.2 Figure definitions

In the class specifications, the class is shown as schema documentation.

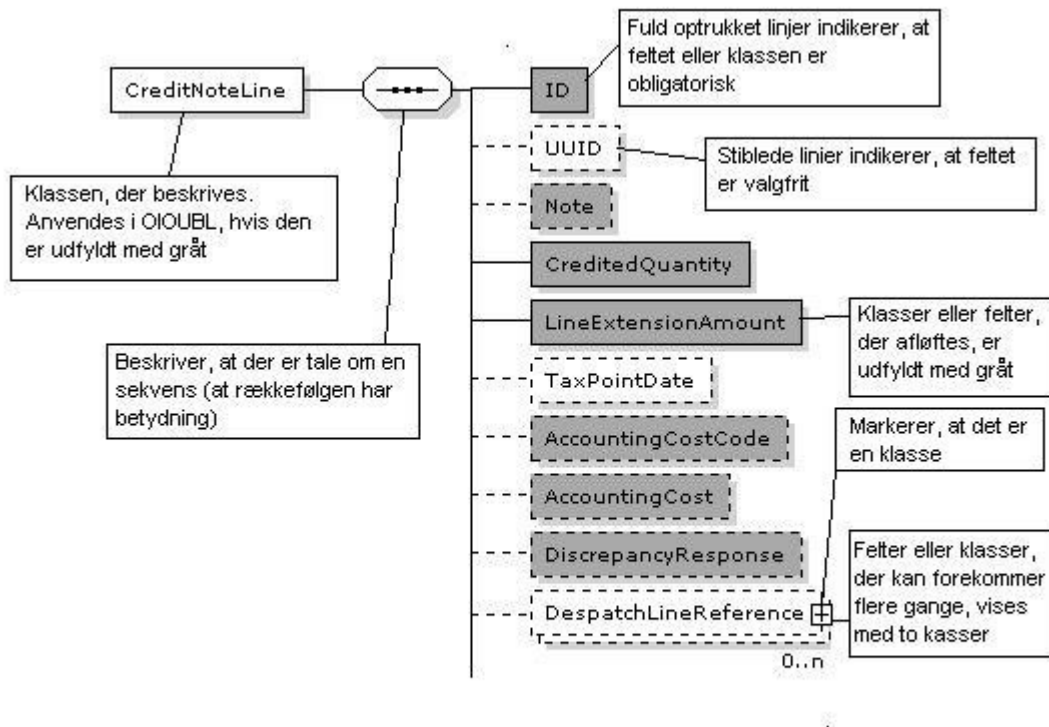

### 1.3 Term definitions

In this specification, the following terms will be used in the tables:

	<b>Term</b>	<b>Explanation</b>
UBL name		The name that is found in the UBL 2.0 schemas
DK-name		The name in Danish
Use		Describes the cardinality, i.e. the rule describing how many instances of the business information entity are allowed: [1] specifies that one and only one instance is allowed. [0..1] means that the business information entity is optional. [0..n] means that null to infinity instances may occur. [1..n] means that no less than one instance to an infinite number of instances may occur.
Alternative term		Specifies a term which is also used to describe the business information entity.
Used		Determines whether the receiver should be expected to be able to decode the described business information, if it is attached. Information that is not used may still, however, be used upon bilateral agreement.
Business rule		Describes the rules that are attached to the business information entity. Business rules are normative, and will be part of the validation of the document in question.
Recommended		Specifies that common practice requires the described business information entity to be attached. This is a

non-normative guide to the use of the business information entity.

Allowed values:

Describes the value set that the business information entity should conform with.

Codelist

Refers to the codelist that the value set should be found in.

Class

A structure of coherent business information.

## 1.4 References

In this document reference is made to other documents within the OIOUBL package.

Filnavn	Titel	Ref
OIOUBL_GUIDE_INTRO	Introduktion til OIOUBL Guidelines	G01
<b>Documentguidelines</b>		
OIOUBL_GUIDE_APPRESPONSE	UBL 2.0 ApplicationResponse	G02
OIOUBL_GUIDE_CATALOGUE	UBL 2.0 Catalogue	G03
OIOUBL_GUIDE_CATALOGUEREQUEST	UBL 2.0 CatalogueRequest	G04
OIOUBL_GUIDE_CATALOGUEDELETION	UBL 2.0 CatalogueDeletion	G05
OIOUBL_GUIDE_CATALOGUEITEMSPECIFICATIONUPDATE	UBL 2.0 CatalogueItemSpecificationUpdate	G06
OIOUBL_GUIDE_CATALOGUEPRICINGUPDATE	UBL 2.0 CataloguePricingUpdate	G07
OIOUBL_GUIDE_ORDER	UBL 2.0 Order	G08
OIOUBL_GUIDE_ORDERRESPONSE	UBL 2.0 OrderResponse	G09
OIOUBL_GUIDE_ORDRERESPONSESIMPLE	UBL 2.0 OrdreResponseSimple	G10
OIOUBL_GUIDE_ORDERCHANGE	UBL 2.0 OrderChange	G11
OIOUBL_GUIDE_ORDERCANCELLATION	UBL 2.0 OrderCancellation	G12
OIOUBL_GUIDE_CREDITNOTE	UBL 2.0 CreditNote	G13
OIOUBL_GUIDE_REMINDER	UBL 2.0 Reminder	G14
OIOUBL_GUIDE_STATEMENT	UBL 2.0 Statement	G15
OIOUBL_GUIDE_INVOICE	UBL 2.0 Invoice	G16
<b>Common guidelines</b>		
OIOUBL_GUIDE_ALLOWANCECHARGE	UBL 2.0 AllowanceCharge	G17
OIOUBL_GUIDE_CURRENCYEXCHANGERATES	UBL 2.0 CurrencyExchangeRates	G18
OIOUBL_GUIDE_DELIVERY	UBL 2.0 Delivery and Delivery Party	G19
OIOUBL_GUIDE_DELIVERYTERMS	OIOUBL Leveringsbetingelser - UBL 2.0 Delivery Terms	G20
OIOUBL_GUIDE_DOCUMENTREF	OIOUBL Dokumentreference - UBL 2.0 Document Reference	G21
OIOUBL_GUIDE_ENDPOINTS	OIOUBL EndepunktID - UBL 2.0 Endpoints	G22
OIOUBL_GUIDE_PARTY	OIOUBL Part - UBL 2.0 Party	G23
OIOUBL_GUIDE_BETALING	OIOUBL Betalingsmåder og betingelser - UBL 2.0 Payment means og payment terms	G24
OIOUBL_GUIDE_PRISER	OIOUBL Priser - UBL 2.0 Prices	G25
OIOUBL_GUIDE_PROFILER	OIOUBL Profiler - UBL 2.0 Profiles	G26
OIOUBL_GUIDE_SKAT	OIOUBL Skat - UBL 2.0 Tax	G27
OIOUBL_GUIDE_TOTALER	OIOUBL Totaler - UBL 2.0 Totals	G28
OIOUBL_GUIDE_DATATYPER	OIOUBL Datatyper - UBL 2.0 Datatypes	G29
OIOUBL_GUIDE_BIBLIOTEK	OIOUBL Fælles klassebibliotek - UBL 2.0 CommonLibrary	G30
OIOUBL_GUIDE_SIGNATUR	OIOUBL Signatur - UBL 2.0 Signature	G31
OIOUBL_GUIDE_UUID	OIOUBL UUID - UBL 2.0 UUID	G32
OIOUBL_GUIDE_UDVIDELSER	OIOUBL Udvidelse - UBL 2.0 Extension	G33

OIOUBL_GUIDE_KONTAKT	OIOUBL Kontakt - UBL 2.0 Contact	G34
OIOUBL_GUIDE_RESPONS	OIOUBL Bekræftelse - UBL 2.0 Respons	G35
OIOUBL_GUIDE_ADRESSER	OIOUBL Adresser - UBL 2.0 Adress	G36
Katalogspecifikke tværgående guidelines		
OIOUBL_GUIDE_KATALOG_ID	OIOUBL Identifikation, versionering og gyldighedsperioder i kataloger	G37
OIOUBL_GUIDE_KATALOG_VAREBESKRIV	OIOUBL Varebeskrivelser og kategorisering i kataloger	G38
OIOUBL_GUIDE_KATALOG_PARTER	OIOUBL Parter i kataloger	G39
OIOUBL_GUIDE_KATALOG_PRISER	OIOUBL Pris og mængde i kataloger	G40
Scenarie pakker		
OIOUBL_SCENARIE_INTRO	Introduction to OIOUBL Procurement Scenarios	S01
OIOUBL_SCENARIE_ADVORD	OIOUBL ADVORD - Advanced Ordering Procurement Cycle	S02
OIOUBL_SCENARIE_BASPRO	OIOUBL BASPRO - Basic procurement Cycle	S03
OIOUBL_SCENARIE_CATEXE	OIOUBL CATEXE - Catalogue Exchange	S04
OIOUBL_SCENARIE_COMDEL	OIOUBL COMDEL - Complex Delivery Procurement Cycle	S05
OIOUBL_SCENARIE_COMORG	OIOUBL COMORG - Complex Organisations Procurement Cycle	S06
OIOUBL_SCENARIE_COMPAY	OIOUBL COMPAY - Complex Payment Cycle	S07

## 2. How to fill in OIOUBL document instances

An Invoice must follow the related UBL schema, and conform to the rules of this guideline. The instances follow the W3C XML specifications, which means that, unless otherwise stated, the normal XML rules apply. It is therefore recommended that an xml encoder is used for reading the documents.

### 2.1 Namespace

A Namespace is a semantic space in which names are unique and attached to a specific interpretation.

Namespaces often occur as libraries, and may be referenced via an alias-variable. The expression:

```
<... xmlns:cac="urn:oasis:names:specification:ubl:schema:xsd:CommonAggregateComponents-2" ...>
```

means that elements with the prefix “cac” (alias variable) belongs to the “... CommomAggregateComponents-2” namespace. The namespace that is referenced by the actual document is

indicated by “xmlns=...”, i.e. without an alias variable. It is recommended to use the alias variables that are specified in UBL, but this is not a requirement. For an OIOUBL document instance to be validated the following namespaces must be specified:

Alias variable	Namespace
	urn:oasis:names:specification:ubl:schema:xsd:Invoice-2
cac	urn:oasis:names:specification:ubl:schema:xsd:CommonAggregateComponents-2
ccts	urn:oasis:names:specification:ubl:schema:xsd:CoreComponentParameters-2
cbc	urn:oasis:names:specification:ubl:schema:xsd:CommonBasicComponents-2
sdt	urn:oasis:names:specification:ubl:schema:xsd:SpecializedDatatypes-2
udt	urn:un:unece:uncefact:data:specification:UnqualifiedDataTypesSchemaModule:2
ext	urn:oasis:names:specification:ubl:schema:xsd:CommonExtensionComponents-2
xsi	http://www.w3.org/2001/XMLSchema-instance

### 2.2 Comments

































Comments may be used in document instances to facilitate any manual processing of the document. This is particularly relevant during the introduction phase of new systems that use OIOUBL. For those who wish to formalize these comments, we recommend the Dublin-Core metadata definitions, see ”

<http://dublincore.org/documents/dcmi-terms/>". The following terms are used in the examples of the scenario descriptions [S01-S07] :

DC-Term	Description	Example
Title	Describes the title of the document instance	BASPRO_01_01_00_Invoice_v2p0.xml
Replaces	Reference to the preceding instance	BASPRO_01_01_00_Invoice_v0p1.xml
Publisher	Describes who is responsible for the document instance.	"IT og Telestyrelsen"
Creator	Describes the person or the system that created the instance.	"OIOERP v 1.0.2 release 34"
Created	Date (and possibly time) of the creation of the document.	2006-09-08
Modified	Date (and possibly time) when the document was last modified.	2006-09-08
Issued	Date (and possibly time) when it was issued.	2006-09-08
ConformsTo	Description of the context that it belongs to.	OIOUBL_ScenarioPackage_BASPRO
Description	General description	"This document is produced as part of the OIOUBL Basic procurement scenario package"
Rights	Any copyrights that apply to the instance.	"It can be used following the Common Creative License"

Only use meta data that you consider applicable, and only enter valid data. From the above list we particularly recommend using the "Creator" term, as this may ease the troubleshooting at the receiver's system. Comments should be specified within the root element of the document.

## 2.3 Process instructions

Process instructions are instructions that are not covered by the OIOUBL standard, but which may be used for controlling other logics. For example, when specifying that an instance is used for test purposes. A process instruction is specified by "                                  



### 3. Statement

### 3.1. Statement

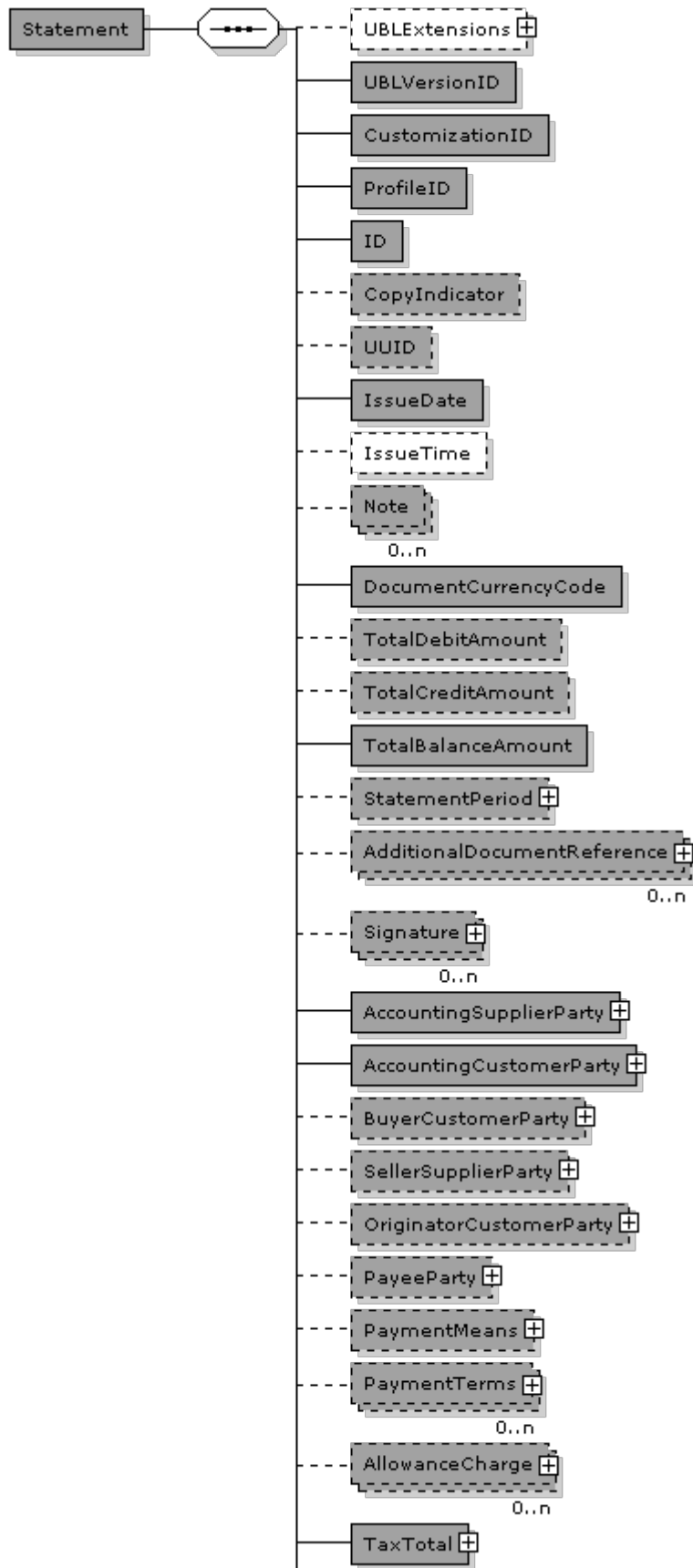



### Statement specification

Name	Statement	Alternative term
<b>Definition</b>	<p>OIOUBL Statement is a document for the exchange of electronic statements. Statements are used only to survey the debt receiveables and financial transactions between customer and supplier. Statements cannot be used as invoices, creditnotes or reminders. Statement is sent from AccountingSupplierParty and AccountingCustomerParty. Statement is structured to fulfill the formal requirements for a valid statement for use in Denmark as well as in foreign countries, including taxnumber, specifications etc. Apart from the formal demands on sender and receiver and the statement content, the electronic version must contain EndPointID and fulfill the requirements in this document guideline. EndPointID is used to identify the "electronic mailbox" where the electronic document is to be delivered and also provides the basis for routing the message.</p>	

### Fields

UBL-Name	Name	Datatype	Usage	Cardinality
UBLVersionID	UBLVersionID	Identifier	Yes	1
CustomizationID	CustomizationID	Identifier	Yes	1
ProfileID	ProfileID	Identifier	Yes	1
ID	ID	Identifier	Yes	1
CopyIndicator	CopyIndicator	Indicator	Yes	0..1
UUID	UUID	Identifier	Yes	0..1
IssueDate	IssueDate	Date	Yes	1
IssueTime	IssueTime	Time	Bilateral	0..1
Note	Note	Text	Yes	0..n
DocumentCurrencyCode	DocumentCurrencyCode	Code	Yes	1
TotalDebitAmount	TotalDebitAmount	Amount	Yes	0..1
TotalCreditAmount	TotalCreditAmount	Amount	Yes	0..1
TotalBalanceAmount	TotalBalanceAmount	Amount	Yes	1

**Subclasses in class Statement**

UBL-Name	Name	Usage	Cardinality	Reference
UBLExtensions	UBLExtensions	Bilateral	0..1	G22
StatementPeriod	StatementPeriod	Yes	0..1	G30 3.78
AdditionalDocumentReference	AdditionalDocumentReference	Yes	0..n	G30 3.36
Signature	Signature	Yes	0..n	G30 3.96
AccountingSupplierParty	AccountingSupplierParty	Yes	1	3.2
AccountingCustomerParty	AccountingCustomerParty	Yes	1	3.3
BuyerCustomerParty	BuyerCustomerParty	Yes	0..1	3.4
SellerSupplierParty	SellerSupplierParty	Yes	0..1	3.5
OriginatorCustomerParty	OriginatorCustomerParty	Yes	0..1	G30 3.27
PayeeParty	PayeeParty	Yes	0..1	3.6
PaymentMeans	PaymentMeans	Yes	0..1	G30 3.76
PaymentTerms	PaymentTerms	Yes	0..n	G30 3.77
AllowanceCharge	AllowanceCharge	Yes	0..n	3.7
TaxTotal	TaxTotal	Yes	1	G30 3.104
StatementLine	StatementLine	Yes	1..n	3.8

## Field specifications

### *UBLVersionID*

<b>Fieldname</b>	UBLVersionID	<b>Alternative term</b>	
<b>Cardinality</b>	1	<b>Usage</b>	Yes
<b>Datatype</b>	Identifier		
<b>Definition</b>	The earliest version of the UBL 2 schema for this document type that defines all of the elements that might be encountered in the current instance.		
<b>Legal values</b>	2.0		
<b>Example</b>	2.0		

### *CustomizationID*

<b>Fieldname</b>	CustomizationID	<b>Alternative term</b>	
<b>Cardinality</b>	1	<b>Usage</b>	Yes
<b>Datatype</b>	Identifier		
<b>Definition</b>	Identifies a user-defined customization of UBL for a specific use.		
<b>Legal values</b>	OIOUBL-2.01		
<b>Example</b>	OIOUBL-2.0		

### *ProfileID*

<b>Fieldname</b>	ProfileID	<b>Alternative term</b>	
<b>Cardinality</b>	1	<b>Usage</b>	Yes
<b>Datatype</b>	Identifier		
<b>Definition</b>	Identifies a user-defined profile of the customization of UBL being used.		
<b>Id list</b>	urn:oiubl:id:profileid-1.1		
<b>Example</b>	Procurement-OrdSim-BilSim-1.0		

### *ID*

<b>Fieldname</b>	ID	<b>Alternative term</b>	
<b>Cardinality</b>	1	<b>Usage</b>	Yes
<b>Datatype</b>	Identifier		
<b>Definition</b>	An identifier for the Credit Note assigned by the Creditor.		
<b>Businessrules</b>	Most important information must be at the end of the ID		
<b>Recommendation</b>	Maximum 35 characters is recommended		
<b>Example</b>	2760708		

### *CopyIndicator*

<b>Fieldname</b>	CopyIndicator	<b>Alternative term</b>	
<b>Cardinality</b>	0..1	<b>Usage</b>	Yes
<b>Datatype</b>	Indicator		
<b>Definition</b>	Indicates whether the Credit Note is a copy (true) or not (false).		
<b>Example</b>	false		

### *UUID*

<b>Fieldname</b>	UUID	<b>Alternative term</b>	
<b>Cardinality</b>	0..1	<b>Usage</b>	Yes
<b>Datatype</b>	Identifier		
<b>Definition</b>	A computer-generated universally unique identifier (UUID) for the Statement instance.		
<b>Example</b>	4e39f644-8819-1029-857a-e388fe63f399		

### *IssueDate*

<b>Fieldname</b>	IssueDate	<b>Alternative term</b>	
<b>Cardinality</b>	1	<b>Usage</b>	Yes
<b>Datatype</b>	Date		
<b>Definition</b>	The date assigned by the Creditor on which the Statement was issued.		
<b>Example</b>	2006-11-01		

### *IssueTime*

<b>Fieldname</b>	IssueTime	<b>Alternative term</b>	
<b>Cardinality</b>	0..1	<b>Usage</b>	Bilateral
<b>Datatype</b>	Time		
<b>Definition</b>	The time assigned by the Creditor on which the Statement was issued.		
<b>Example</b>	12:35:00		

**Note**

<b>Fieldname</b>	Note	<b>Alternative term</b>	
<b>Cardinality</b>	0..n	<b>Usage</b>	Yes
<b>Datatype</b>	Text		
<b>Definition</b>	Free-form text applying to the Statement. This element may contain notes or any other similar information that is not contained explicitly in another structure.		
<b>Businessrules</b>	Only one language allowed		
<b>Example</b>	Kontouttoget afsluttet den 15. august		

**DocumentCurrencyCode**

<b>Fieldname</b>	DocumentCurrencyCode	<b>Alternative term</b>	OIOUBL_GUIDE_CURRENCY
<b>Cardinality</b>	1	<b>Usage</b>	Yes
<b>Datatype</b>	Code		
<b>Definition</b>	The default currency for the Statement.		
<b>Codelist</b>	urn:un:unece:uncefact:codelist:specification:54217:2001		
<b>See also</b>	OIOUBL_GUIDE_CURRENCY ( OIO )		
<b>Example</b>	DKK		

**TotalDebitAmount**

<b>Fieldname</b>	TotalDebitAmount	<b>Alternative term</b>	
<b>Cardinality</b>	0..1	<b>Usage</b>	Yes
<b>Datatype</b>	Amount		
<b>Definition</b>	The totals of all debit amounts for the Statement.		
<b>Businessrules</b>	Either Debet or Credit amount is required		
<b>Dependency</b>	../TotalCreditAmount		
<b>Example</b>	5000.00		

**TotalCreditAmount**

<b>Fieldname</b>	TotalCreditAmount	<b>Alternative term</b>	
<b>Cardinality</b>	0..1	<b>Usage</b>	Yes
<b>Datatype</b>	Amount		
<b>Definition</b>	The totals of all credit amounts for the Statement.		
<b>Businessrules</b>	Either Debet or Credit amount is required		
<b>Dependency</b>	../TotalDebitAmount		
<b>Example</b>	342.50		

**TotalBalanceAmount**

<b>Fieldname</b>	TotalBalanceAmount	<b>Alternative term</b>	
<b>Cardinality</b>	1	<b>Usage</b>	Yes
<b>Datatype</b>	Amount		
<b>Definition</b>	The total amount for the Statement.		
<b>Example</b>	410.00		

**Class Specification****StatementPeriod**

<b>Classname</b>	StatementPeriod	<b>Alternative term</b>	
<b>Cardinality</b>	0..1	<b>Usage</b>	Yes
<b>Datatype</b>	Period		
<b>Definition</b>	An association to period(s) to which the Statement applies.		
<b>See section</b>	G30 3.78		

**AdditionalDocumentReference**

<b>Classname</b>	AdditionalDocumentReference	<b>Alternative term</b>	OIOUBL_GUIDE_DOCUMENTREF
<b>Cardinality</b>	0..n	<b>Usage</b>	Yes
<b>Datatype</b>	DocumentReference		
<b>Definition</b>	An association to other documents.		
<b>See section</b>	G30 3.36		
<b>See also</b>	OIOUBL_GUIDE_DOCUMENTREF ( OIO )		

**Signature**

<b>Classname</b>	Signature	<b>Alternative term</b>	OIOUBL_GUIDE_SIGNATURE
<b>Cardinality</b>	0..n	<b>Usage</b>	Yes
<b>Datatype</b>	Signature		
<b>Definition</b>	Associates the Statement with zero or more signatures.		
<b>See section</b>	G30 3.96		
<b>See also</b>	OIOUBL_GUIDE_SIGNATURE ( OIO )		

**AccountingSupplierParty**

<b>Classname</b>	AccountingSupplierParty	<b>Alternative term</b>	OIOUBL_GUIDE_PARTIES
<b>Cardinality</b>	1	<b>Usage</b>	Yes
<b>Datatype</b>	SupplierParty		
<b>Definition</b>	An association to the Accounting Supplier Party.		
<b>See section</b>	3.2		
<b>See also</b>	OIOUBL_GUIDE_PARTIES ( OIO )		

**AccountingCustomerParty**

<b>Classname</b>	AccountingCustomerParty	<b>Alternative term</b>	OIOUBL_GUIDE_PARTIES
<b>Cardinality</b>	1	<b>Usage</b>	Yes
<b>Datatype</b>	CustomerParty		
<b>Definition</b>	An association to the Accounting Customer Party.		
<b>See section</b>	3.3		
<b>See also</b>	OIOUBL_GUIDE_PARTIES ( OIO )		

**BuyerCustomerParty**

<b>Classname</b>	BuyerCustomerParty	<b>Alternative term</b>	OIOUBL_GUIDE_PARTIES
<b>Cardinality</b>	0..1	<b>Usage</b>	Yes
<b>Datatype</b>	CustomerParty		
<b>Definition</b>	An association to the Buyer.		
<b>See section</b>	3.4		
<b>See also</b>	OIOUBL_GUIDE_PARTIES ( OIO )		

**SellerSupplierParty**

<b>Classname</b>	SellerSupplierParty	<b>Alternative term</b>	OIOUBL_GUIDE_PARTIES
<b>Cardinality</b>	0..1	<b>Usage</b>	Yes
<b>Datatype</b>	SupplierParty		
<b>Definition</b>	An association to the Seller.		
<b>See section</b>	3.5		
<b>See also</b>	OIOUBL_GUIDE_PARTIES ( OIO )		

**OriginatorCustomerParty**

<b>Classname</b>	OriginatorCustomerParty	<b>Alternative term</b>	OIOUBL_GUIDE_PARTIES
<b>Cardinality</b>	0..1	<b>Usage</b>	Yes
<b>Datatype</b>	CustomerParty		
<b>Definition</b>	An association to the Originator.		
<b>See section</b>	G30 3.27		
<b>See also</b>	OIOUBL_GUIDE_PARTIES ( OIO )		

**PayeeParty**

<b>Classname</b>	PayeeParty	<b>Alternative term</b>	OIOUBL_GUIDE_PARTIES
<b>Cardinality</b>	0..1	<b>Usage</b>	Yes
<b>Datatype</b>	Party		
<b>Definition</b>	An association to the Payee.		
<b>See section</b>	3.6		
<b>See also</b>	OIOUBL_GUIDE_PARTIES ( OIO )		

**PaymentMeans**

<b>Classname</b>	PaymentMeans	<b>Alternative term</b>	OIOUBL_GUIDE_PAYMENT
<b>Cardinality</b>	0..1	<b>Usage</b>	Yes
<b>Datatype</b>	PaymentMeans		
<b>Definition</b>	An association to Payment Means.		
<b>See section</b>	G30 3.76		
<b>See also</b>	OIOUBL_GUIDE_PAYMENT ( OIO )		

**PaymentTerms**

<b>Classname</b>	PaymentTerms	<b>Alternative term</b>	OIOUBL_GUIDE_PAYMENT
<b>Cardinality</b>	0..n	<b>Usage</b>	Yes
<b>Datatype</b>	PaymentTerms		
<b>Definition</b>	An association to Payment Terms.		
<b>See section</b>	G30 3.77		
<b>See also</b>	OIOUBL_GUIDE_PAYMENT ( OIO )		

**AllowanceCharge**

<b>Classname</b>	AllowanceCharge	<b>Alternative term</b>	OIOUBL_GUIDE_ALLOWANCE
<b>Cardinality</b>	0..n	<b>Usage</b>	Yes
<b>Datatype</b>	AllowanceCharge		
<b>Definition</b>	An association to Allowances and Charges that apply to the Statement period as a whole.		
<b>See section</b>	3.7		
<b>See also</b>	OIOUBL_GUIDE_ALLOWANCE ( OIO )		

**TaxTotal**

<b>Classname</b>	TaxTotal	<b>Alternative term</b>	OIOUBL_GUIDE_TAX
<b>Cardinality</b>	1	<b>Usage</b>	Yes
<b>Datatype</b>	TaxTotal		
<b>Definition</b>	An association with summary information for particular taxes.		
<b>See section</b>	G30 3.104		
<b>See also</b>	OIOUBL_GUIDE_TAX ( OIO )		

**StatementLine**

<b>Classname</b>	StatementLine	<b>Alternative term</b>	
<b>Cardinality</b>	1..n	<b>Usage</b>	Yes
<b>Datatype</b>	Statement		
<b>Definition</b>	An association to one or more Statement Lines.		
<b>See section</b>	3.8		

**Excluded classes and fields in Statement**

Name	Name	Type
LineCountNumeric	LineCountNumeric	Field



### 3.2. Statement.AccountingSupplierParty

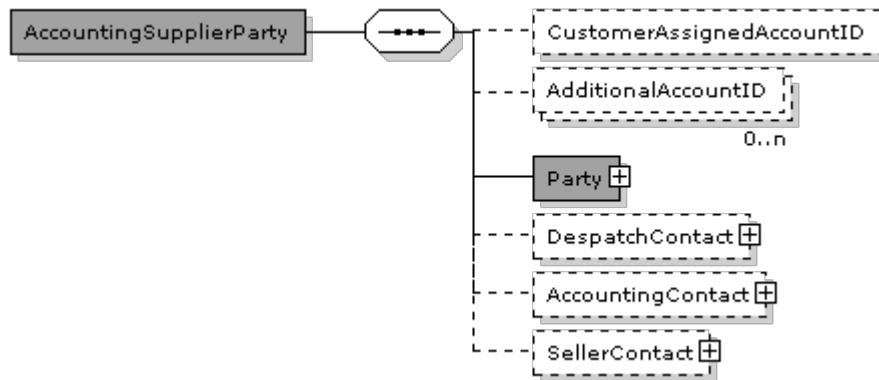

#### AccountingSupplierParty (Statement.AccountingSupplierParty) specification

<b>Name</b>	Statement.AccountingSupplierParty	<b>Alternative term</b>	
<b>Definition</b>	Information about the Supplier Party		

#### Fields

UBL-Name	Name	Datatype	Usage	Cardinality
CustomerAssignedAccountID	CustomerAssignedAccountID	Identifier	Bilateral	0..1
AdditionalAccountID	AdditionalAccountID	Identifier	Bilateral	0..n

#### Subclasses in class AccountingSupplierParty (Statement.AccountingSupplierParty)

UBL-Name	Name	Usage	Cardinality	Reference
Party	Party	Yes	1	3.2.1
DespatchContact	DespatchContact	Bilateral	0..1	G30 3.21
AccountingContact	AccountingContact	Bilateral	0..1	G30 3.21
SellerContact	SellerContact	Bilateral	0..1	G30 3.21

#### Field specifications

##### CustomerAssignedAccountID

<b>Fieldname</b>	CustomerAssignedAccountID	<b>Alternative term</b>	
<b>Cardinality</b>	0..1	<b>Usage</b>	Bilateral
<b>Datatype</b>	Identifier		
<b>Definition</b>	An identifier for the Supplier assigned by the Customer; the Customer's internal reference for the Supplier		

##### AdditionalAccountID

<b>Fieldname</b>	AdditionalAccountID	<b>Alternative term</b>	
<b>Cardinality</b>	0..n	<b>Usage</b>	Bilateral
<b>Datatype</b>	Identifier		
<b>Definition</b>	An identifier for the Supplier assigned by a third party		

**Class Specification****Party**

<b>Classname</b>	Party	<b>Alternative term</b>	
<b>Cardinality</b>	1	<b>Usage</b>	Yes
<b>Datatype</b>	Party		
<b>Definition</b>	An association to Party		
<b>See section</b>	3.2.1		

**DespatchContact**

<b>Classname</b>	DespatchContact	<b>Alternative term</b>	
<b>Cardinality</b>	0..1	<b>Usage</b>	Bilateral
<b>Datatype</b>	Contact		
<b>Definition</b>	An association to Despatch		
<b>See section</b>	G30 3.21		

**AccountingContact**

<b>Classname</b>	AccountingContact	<b>Alternative term</b>	
<b>Cardinality</b>	0..1	<b>Usage</b>	Bilateral
<b>Datatype</b>	Contact		
<b>Definition</b>	An association to the Supplier Accounting Contact		
<b>See section</b>	G30 3.21		

**SellerContact**

<b>Classname</b>	SellerContact	<b>Alternative term</b>	
<b>Cardinality</b>	0..1	<b>Usage</b>	Bilateral
<b>Datatype</b>	Contact		
<b>Definition</b>	An association to the Seller		
<b>See section</b>	G30 3.21		

**Excluded classes and fields in AccountingSupplierParty (Statement.AccountingSupplierParty)**

Name	Name	Type
DataSendingCapability	DataSendingCapability	Field

### 3.2.1. Statement.AccountingSupplierParty.Party

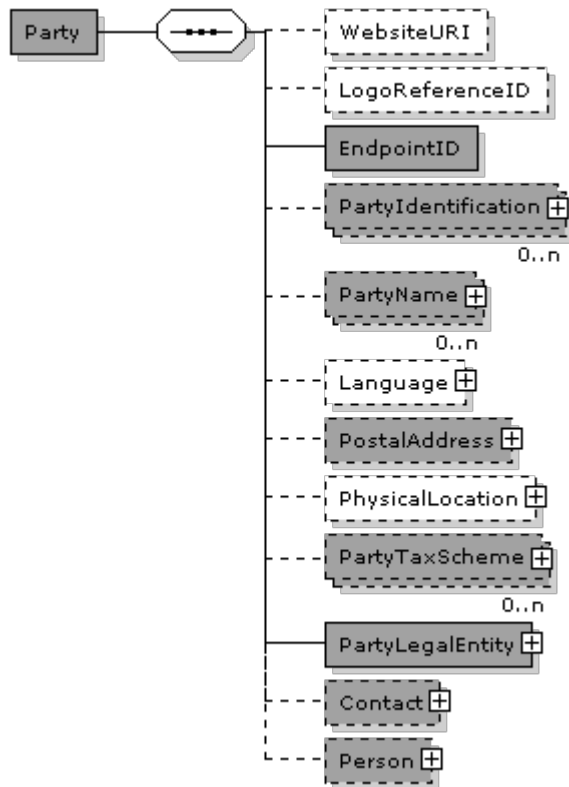

#### Party (Statement.AccountingSupplierParty.Party) specification

<b>Name</b>	Statement.AccountingSupplierParty.Party	<b>Alternative term</b>	OIOUBL_GUIDE_PARTIES
<b>Definition</b>	Information about an organisation, sub-organisation or individual fulfilling a role in a business process		
<b>See also</b>	OIOUBL_GUIDE_PARTIES ( OIO )		

#### Fields

UBL-Name	Name	Datatype	Usage	Cardinality
WebsiteURI	WebsiteURI	Identifier	Bilateral	0..1
LogoReferenceID	LogoReferenceID	Identifier	Bilateral	0..1
EndpointID	EndpointID	Identifier	Yes	1

**Subclasses in class Party (Statement.AccountingSupplierParty.Party)**

UBL-Name	Name	Usage	Cardinality	Reference
PartyIdentification	PartyIdentification	Yes	0..n	G30 3.71
PartyName	PartyName	Yes	0..n	G30 3.73
Language	Language	Bilateral	0..1	G30 3.56
PostalAddress	PostalAddress	Yes	0..1	G30 3.1
PhysicalLocation	PhysicalLocation	Bilateral	0..1	G30 3.60
PartyTaxScheme	PartyTaxScheme	Yes	0..n	G30 3.74
PartyLegalEntity	PartyLegalEntity	Yes	1	G30 3.72
Contact	Contact	Yes	0..1	G30 3.21
Person	Person	Yes	0..1	G30 3.79

**Field specifications****WebsiteURI**

Fieldname	WebsiteURI	Alternative term	
Cardinality	0..1	Usage	Bilateral
Datatype	Identifier		
Definition	The Uniform Resource Identifier (URI) of the Party		

**LogoReferenceID**

Fieldname	LogoReferenceID	Alternative term	
Cardinality	0..1	Usage	Bilateral
Datatype	Identifier		
Definition	A Party's logo		

**EndpointID**

Fieldname	EndpointID	Alternative term	OIOUBL_GUIDE_ENDPOINT
Cardinality	1	Usage	Yes
Datatype	Identifier		
Definition	Identifies the end point of the routing service, e.g. EAN Location Number, GLN		
Id schemelist	urn:oiubl:scheme:endpointid-1.1		
See also	OIOUBL_GUIDE_ENDPOINT ( OIO )		

**Class Specification****PartyIdentification**

Classname	PartyIdentification	Alternative term	
Cardinality	0..n	Usage	Yes
Datatype	PartyIdentification		
Definition	An association to Party Identification		
See section	G30 3.71		

**PartyName**

Classname	PartyName	Alternative term	
Cardinality	0..n	Usage	Yes
Datatype	PartyName		
Definition	An association to Party Name. Party Name must be used where no Party Identification is used.		
Businessrules	Mandatory if PartyIdentification.ID not used. Only use more than 1 if multilanguage.		
Recommendation	At Header level PartyName should be supplied		
Dependency	../PartyIdentification		
See section	G30 3.73		

**Language**

## 3.2.1. Statement.AccountingSupplierParty.Party

<b>Classname</b>	Language	<b>Alternative term</b>	
<b>Cardinality</b>	0..1	<b>Usage</b>	Bilateral
<b>Datatype</b>	Language		
<b>Definition</b>	An association to Language		
<b>See section</b>	G30 3.56		

**PostalAddress**

<b>Classname</b>	PostalAddress	<b>Alternative term</b>	
<b>Cardinality</b>	0..1	<b>Usage</b>	Yes
<b>Datatype</b>	Address		
<b>Definition</b>	The Party's postal address		
<b>Recommendation</b>	The Address should be specified on header level and must be of the type StructuredDK.		
<b>See section</b>	G30 3.1		

**PhysicalLocation**

<b>Classname</b>	PhysicalLocation	<b>Alternative term</b>	
<b>Cardinality</b>	0..1	<b>Usage</b>	Bilateral
<b>Datatype</b>	Location		
<b>Definition</b>	The Party's visiting address		
<b>Recommendation</b>	Only if different from PostalAddress		
<b>See section</b>	G30 3.60		

**PartyTaxScheme**

<b>Classname</b>	PartyTaxScheme	<b>Alternative term</b>	OIOUBL_GUIDE_TAX
<b>Cardinality</b>	0..n	<b>Usage</b>	Yes
<b>Datatype</b>	PartyTaxScheme		
<b>Definition</b>	An association to Party Tax Scheme		
<b>See section</b>	G30 3.74		
<b>See also</b>	OIOUBL_GUIDE_TAX ( OIO )		

**PartyLegalEntity**

<b>Classname</b>	PartyLegalEntity	<b>Alternative term</b>	OIOUBL_GUIDE_TAX
<b>Cardinality</b>	1	<b>Usage</b>	Yes
<b>Datatype</b>	PartyLegalEntity		
<b>Definition</b>	An association to Party Legal Entity		
<b>See section</b>	G30 3.72		
<b>See also</b>	OIOUBL_GUIDE_TAX ( OIO )		

**Contact**

<b>Classname</b>	Contact	<b>Alternative term</b>	OIOUBL_GUIDE_CONTACT
<b>Cardinality</b>	0..1	<b>Usage</b>	Yes
<b>Datatype</b>	Contact		
<b>Definition</b>	An association to Contact		
<b>See section</b>	G30 3.21		
<b>See also</b>	OIOUBL_GUIDE_CONTACT ( G23 )		

**Person**

<b>Classname</b>	Person	<b>Alternative term</b>	
<b>Cardinality</b>	0..1	<b>Usage</b>	Yes
<b>Datatype</b>	Person		
<b>Definition</b>	An association to a Person.		
<b>See section</b>	G30 3.79		

**Excluded classes and fields in Party (Statement.AccountingSupplierParty.Party)**

Name	Name	Type
MarkCareIndicator	MarkCareIndicator	Field
MarkAttentionIndicator	MarkAttentionIndicator	Field
AgentParty	AgentParty	Class



### 3.3. Statement.AccountingCustomerParty

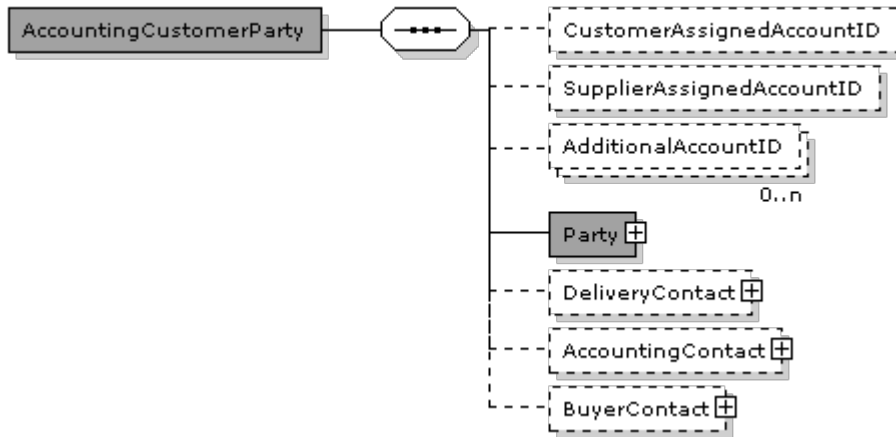

#### AccountingCustomerParty (Statement.AccountingCustomerParty) specification

<b>Name</b>	Statement.AccountingCustomerParty	<b>Alternative term</b>	
<b>Definition</b>	Information about the Customer Party		

#### Fields

UBL-Name	Name	Datatype	Usage	Cardinality
CustomerAssignedAccountID	CustomerAssignedAccountID	Identifier	Bilateral	0..1
SupplierAssignedAccountID	SupplierAssignedAccountID	Identifier	Bilateral	0..1
AdditionalAccountID	AdditionalAccountID	Identifier	Bilateral	0..n

#### Subclasses in class AccountingCustomerParty (Statement.AccountingCustomerParty)

UBL-Name	Name	Usage	Cardinality	Reference
Party	Party	Yes	1	3.3.1
DeliveryContact	DeliveryContact	Bilateral	0..1	G30 3.29
AccountingContact	AccountingContact	Bilateral	0..1	
BuyerContact	BuyerContact	Bilateral	0..1	

**Field specifications****CustomerAssignedAccountID**

<b>Fieldname</b>	CustomerAssignedAccountID	<b>Alternative term</b>	
<b>Cardinality</b>	0..1	<b>Usage</b>	Bilateral
<b>Datatype</b>	Identifier		
<b>Definition</b>	An identifier referring to an account for the Customer assigned by the Customer itself		

**SupplierAssignedAccountID**

<b>Fieldname</b>	SupplierAssignedAccountID	<b>Alternative term</b>	
<b>Cardinality</b>	0..1	<b>Usage</b>	Bilateral
<b>Datatype</b>	Identifier		
<b>Definition</b>	An identifier referring to an account for the Customer assigned by the Supplier		

**AdditionalAccountID**

<b>Fieldname</b>	AdditionalAccountID	<b>Alternative term</b>	
<b>Cardinality</b>	0..n	<b>Usage</b>	Bilateral
<b>Datatype</b>	Identifier		
<b>Definition</b>	An identifier referring to an account for the Customer assigned by a third party		

**Class Specification****Party**

<b>Classname</b>	Party	<b>Alternative term</b>	
<b>Cardinality</b>	1	<b>Usage</b>	Yes
<b>Datatype</b>	Party		
<b>Definition</b>	An association to Party		
<b>See section</b>	3.3.1		

**DeliveryContact**

<b>Classname</b>	DeliveryContact	<b>Alternative term</b>	
<b>Cardinality</b>	0..1	<b>Usage</b>	Bilateral
<b>Datatype</b>	Contact		
<b>Definition</b>	An association to Delivery Contact.		
<b>See section</b>	G30 3.29		

**AccountingContact**

<b>Classname</b>	AccountingContact	<b>Alternative term</b>	
<b>Cardinality</b>	0..1	<b>Usage</b>	Bilateral
<b>Datatype</b>	Contact		
<b>Definition</b>	An association to Customer Accounting Contact.		
<b>See section</b>	G30 3.		

**BuyerContact**

<b>Classname</b>	BuyerContact	<b>Alternative term</b>	
<b>Cardinality</b>	0..1	<b>Usage</b>	Bilateral
<b>Datatype</b>	Contact		
<b>Definition</b>	An association to Buyer Contact.		
<b>See section</b>	G30 3.		

**Excluded classes and fields in AccountingCustomerParty (Statement.AccountingCustomerParty)**

None



### 3.3.1. Statement.AccountingCustomerParty.Party

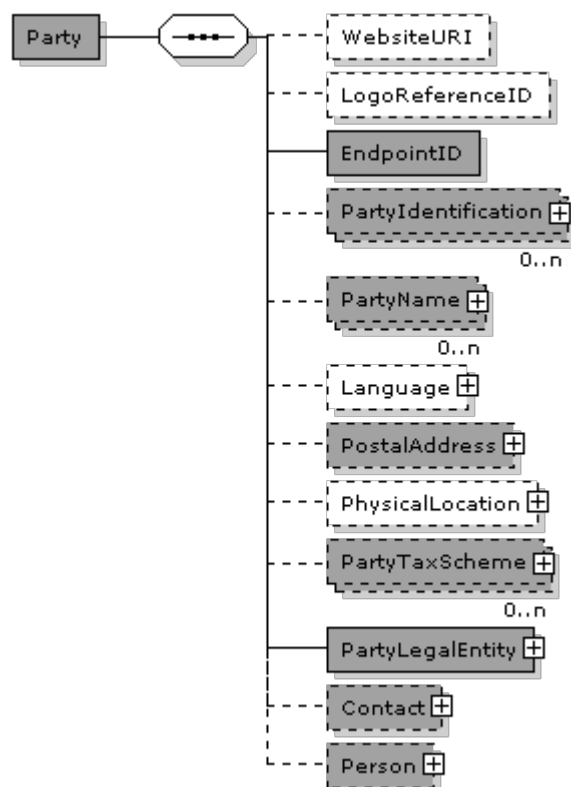

#### Party (Statement.AccountingCustomerParty.Party) specification

<b>Name</b>	Statement.AccountingCustomerParty.Party	<b>Alternative term</b>	OIOUBL_GUIDE_PARTIES
<b>Definition</b>	Information about an organisation, sub-organisation or individual fulfilling a role in a business process		
<b>See also</b>	OIOUBL_GUIDE_PARTIES ( OIO )		

#### Fields

UBL-Name	Name	Datatype	Usage	Cardinality
WebsiteURI	WebsiteURI	Identifier	Bilateral	0..1
LogoReferenceID	LogoReferenceID	Identifier	Bilateral	0..1
EndpointID	EndpointID	Identifier	Yes	1

**Subclasses in class Party (Statement.AccountingCustomerParty.Party)**

UBL-Name	Name	Usage	Cardinality	Reference
PartyIdentification	PartyIdentification	Yes	0..n	G30 3.71
PartyName	PartyName	Yes	0..n	G30 3.73
Language	Language	Bilateral	0..1	G30 3.56
PostalAddress	PostalAddress	Yes	0..1	G30 3.1
PhysicalLocation	PhysicalLocation	Bilateral	0..1	G30 3.60
PartyTaxScheme	PartyTaxScheme	Yes	0..n	G30 3.74
PartyLegalEntity	PartyLegalEntity	Yes	1	G30 3.72
Contact	Contact	Yes	0..1	3.3.1.1
Person	Person	Yes	0..1	G30 3.79

**Field specifications****WebsiteURI**

Fieldname	WebsiteURI	Alternative term	
Cardinality	0..1	Usage	Bilateral
Datatype	Identifier		
Definition	The Uniform Resource Identifier (URI) of the Party		

**LogoReferenceID**

Fieldname	LogoReferenceID	Alternative term	
Cardinality	0..1	Usage	Bilateral
Datatype	Identifier		
Definition	A Party's logo		

**EndpointID**

Fieldname	EndpointID	Alternative term	OIOUBL_GUIDE_ENDPOINT
Cardinality	1	Usage	Yes
Datatype	Identifier		
Definition	Identifies the end point of the routing service, e.g. EAN Location Number, GLN		
Id schemelist	urn:oiubl:scheme:endpointid-1.1		
See also	OIOUBL_GUIDE_ENDPOINT ( OIO )		

**Class Specification****PartyIdentification**

Classname	PartyIdentification	Alternative term	
Cardinality	0..n	Usage	Yes
Datatype	PartyIdentification		
Definition	An association to Party Identification		
See section	G30 3.71		

**PartyName**

Classname	PartyName	Alternative term	
Cardinality	0..n	Usage	Yes
Datatype	PartyName		
Definition	An association to Party Name. Party Name must be used where no Party Identification is used.		
Businessrules	Mandatory if PartyIdentification.ID not used. Only use more than 1 if multilanguage.		
Recommendation	At Header level PartyName should be supplied		
Dependency	../PartyIdentification		
See section	G30 3.73		

**Language**

## 3.3.1. Statement.AccountingCustomerParty.Party

<b>Classname</b>	Language	<b>Alternative term</b>	
<b>Cardinality</b>	0..1	<b>Usage</b>	Bilateral
<b>Datatype</b>	Language		
<b>Definition</b>	An association to Language		
<b>See section</b>	G30 3.56		

**PostalAddress**

<b>Classname</b>	PostalAddress	<b>Alternative term</b>	
<b>Cardinality</b>	0..1	<b>Usage</b>	Yes
<b>Datatype</b>	Address		
<b>Definition</b>	The Party's postal address		
<b>Recommendation</b>	The Address should be specified on header level and must be of the type StructuredDK.		
<b>See section</b>	G30 3.1		

**PhysicalLocation**

<b>Classname</b>	PhysicalLocation	<b>Alternative term</b>	
<b>Cardinality</b>	0..1	<b>Usage</b>	Bilateral
<b>Datatype</b>	Location		
<b>Definition</b>	The Party's postal address		
<b>Recommendation</b>	Only if different from PostalAddress		
<b>See section</b>	G30 3.60		

**PartyTaxScheme**

<b>Classname</b>	PartyTaxScheme	<b>Alternative term</b>	OIOUBL_GUIDE_TAX
<b>Cardinality</b>	0..n	<b>Usage</b>	Yes
<b>Datatype</b>	PartyTaxScheme		
<b>Definition</b>	An association to Party Tax Scheme		
<b>See section</b>	G30 3.74		
<b>See also</b>	OIOUBL_GUIDE_TAX ( OIO )		

**PartyLegalEntity**

<b>Classname</b>	PartyLegalEntity	<b>Alternative term</b>	OIOUBL_GUIDE_TAX
<b>Cardinality</b>	1	<b>Usage</b>	Yes
<b>Datatype</b>	PartyLegalEntity		
<b>Definition</b>	An association to Party Legal Entity		
<b>See section</b>	G30 3.72		
<b>See also</b>	OIOUBL_GUIDE_TAX ( OIO )		

**Contact**

<b>Classname</b>	Contact	<b>Alternative term</b>	OIOUBL_GUIDE_CONTACT
<b>Cardinality</b>	0..1	<b>Usage</b>	Yes
<b>Datatype</b>	Contact		
<b>Definition</b>	An association to Contact		
<b>See section</b>	3.3.1.1		
<b>See also</b>	OIOUBL_GUIDE_CONTACT ( G23 )		

**Person**

<b>Classname</b>	Person	<b>Alternative term</b>	
<b>Cardinality</b>	0..1	<b>Usage</b>	Yes
<b>Datatype</b>	Person		
<b>Definition</b>	An association to a Person.		
<b>See section</b>	G30 3.79		

**Excluded classes and fields in Party (Statement.AccountingCustomerParty.Party)**

Name	Name	Type
MarkCareIndicator	MarkCareIndicator	Field
MarkAttentionIndicator	MarkAttentionIndicator	Field
AgentParty	AgentParty	Class



### 3.3.1.1. Statement.AccountingCustomerParty.Party.Contact

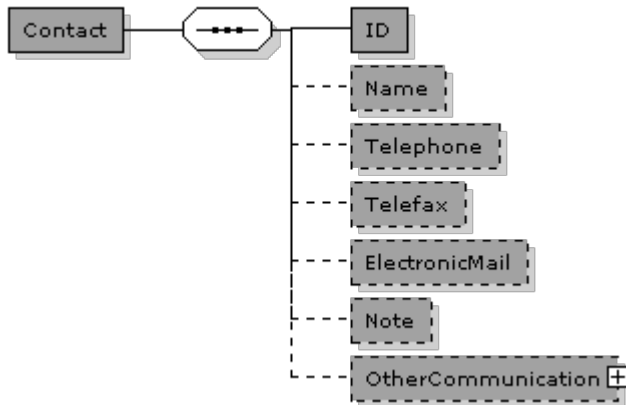

#### Contact (Statement.AccountingCustomerParty.Party.Contact) specification

<b>Name</b>	Statement.AccountingCustomerParty.Party.Contact	<b>Alternative term</b>	
<b>Definition</b>	Information about a contactable person or organisation department		

#### Fields

UBL-Name	Name	Datatype	Usage	Cardinality
ID	ID	Identifier	Yes	1
Name	Name	Name	Yes	0..1
Telephone	Telephone	Text	Yes	0..1
Telefax	Telefax	Text	Yes	0..1
ElectronicMail	ElectronicMail	Text	Yes	0..1
Note	Note	Text	Yes	0..1

#### Subclasses in class Contact (Statement.AccountingCustomerParty.Party.Contact)

UBL-Name	Name	Usage	Cardinality	Reference
OtherCommunication	OtherCommunication	Yes	0..1	G30 3.19

**Field specifications****ID**

<b>Fieldname</b>	ID	<b>Alternative term</b>	
<b>Cardinality</b>	1	<b>Usage</b>	Yes
<b>Datatype</b>	Identifier		
<b>Definition</b>	An identifier for the Contact		
<b>Businessrules</b>	The customer reference to person initiating the process		

**Name**

<b>Fieldname</b>	Name	<b>Alternative term</b>	
<b>Cardinality</b>	0..1	<b>Usage</b>	Yes
<b>Datatype</b>	Name		
<b>Definition</b>	The name of the Contact		

**Telephone**

<b>Fieldname</b>	Telephone	<b>Alternative term</b>	
<b>Cardinality</b>	0..1	<b>Usage</b>	Yes
<b>Datatype</b>	Text		
<b>Definition</b>	The telephone number of the Contact		

**Telefax**

<b>Fieldname</b>	Telefax	<b>Alternative term</b>	
<b>Cardinality</b>	0..1	<b>Usage</b>	Yes
<b>Datatype</b>	Text		
<b>Definition</b>	The fax number of the Contact		
<b>Example</b>	89113434		

**ElectronicMail**

<b>Fieldname</b>	ElectronicMail	<b>Alternative term</b>	
<b>Cardinality</b>	0..1	<b>Usage</b>	Yes
<b>Datatype</b>	Text		
<b>Definition</b>	The Email address of the Contact		
<b>Example</b>	pa@ubl.dk		

**Note**

<b>Fieldname</b>	Note	<b>Alternative term</b>	
<b>Cardinality</b>	0..1	<b>Usage</b>	Yes
<b>Datatype</b>	Text		
<b>Definition</b>	A note describing the circumstances in which the Contact can be used such as 'Emergency' or 'After Hours'		
<b>Example</b>	Can only be used between 14 and 17		

**Class Specification****OtherCommunication**

<b>Classname</b>	OtherCommunication	<b>Alternative term</b>	
<b>Cardinality</b>	0..1	<b>Usage</b>	Yes
<b>Datatype</b>	Communication		
<b>Definition</b>	An association to Other Communication		
<b>See section</b>	G30 3.19		

**Excluded classes and fields in Contact (Statement.AccountingCustomerParty.Party.Contact)**

None

### 3.4. Statement.BuyerCustomerParty

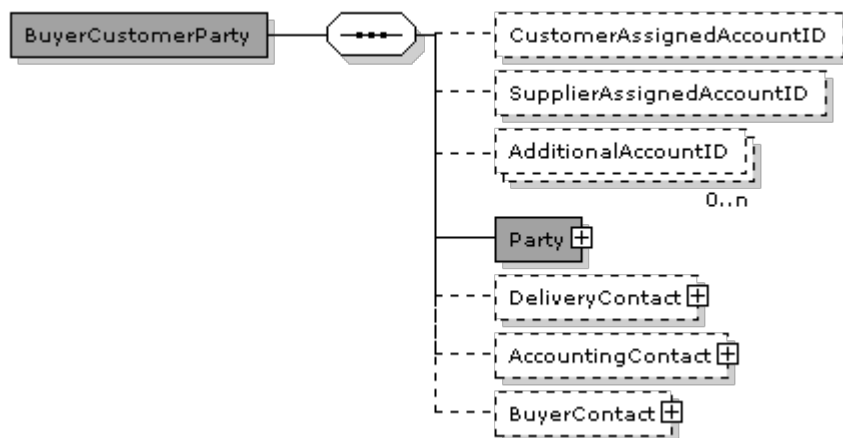

#### BuyerCustomerParty (Statement.BuyerCustomerParty) specification

<b>Name</b>	Statement.BuyerCustomerParty	<b>Alternative term</b>	
<b>Definition</b>	Information about the Customer Party		

#### Fields

UBL-Name	Name	Datatype	Usage	Cardinality
CustomerAssignedAccountID	CustomerAssignedAccountID	Identifier	Bilateral	0..1
SupplierAssignedAccountID	SupplierAssignedAccountID	Identifier	Bilateral	0..1
AdditionalAccountID	AdditionalAccountID	Identifier	Bilateral	0..n

#### Subclasses in class BuyerCustomerParty (Statement.BuyerCustomerParty)

UBL-Name	Name	Usage	Cardinality	Reference
Party	Party	Yes	1	3.4.1
DeliveryContact	DeliveryContact	Bilateral	0..1	G30 3.29
AccountingContact	AccountingContact	Bilateral	0..1	
BuyerContact	BuyerContact	Bilateral	0..1	

**Field specifications****CustomerAssignedAccountID**

<b>Fieldname</b>	CustomerAssignedAccountID	<b>Alternative term</b>	
<b>Cardinality</b>	0..1	<b>Usage</b>	Bilateral
<b>Datatype</b>	Identifier		
<b>Definition</b>	An identifier referring to an account for the Customer assigned by the Customer itself		

**SupplierAssignedAccountID**

<b>Fieldname</b>	SupplierAssignedAccountID	<b>Alternative term</b>	
<b>Cardinality</b>	0..1	<b>Usage</b>	Bilateral
<b>Datatype</b>	Identifier		
<b>Definition</b>	An identifier referring to an account for the Customer assigned by the Supplier		

**AdditionalAccountID**

<b>Fieldname</b>	AdditionalAccountID	<b>Alternative term</b>	
<b>Cardinality</b>	0..n	<b>Usage</b>	Bilateral
<b>Datatype</b>	Identifier		
<b>Definition</b>	An identifier referring to an account for the Customer assigned by a third party		

**Class Specification****Party**

<b>Classname</b>	Party	<b>Alternative term</b>	
<b>Cardinality</b>	1	<b>Usage</b>	Yes
<b>Datatype</b>	Party		
<b>Definition</b>	An association to Party		
<b>See section</b>	3.4.1		

**DeliveryContact**

<b>Classname</b>	DeliveryContact	<b>Alternative term</b>	
<b>Cardinality</b>	0..1	<b>Usage</b>	Bilateral
<b>Datatype</b>	Contact		
<b>Definition</b>	An association to Delivery Contact.		
<b>See section</b>	G30 3.29		

**AccountingContact**

<b>Classname</b>	AccountingContact	<b>Alternative term</b>	
<b>Cardinality</b>	0..1	<b>Usage</b>	Bilateral
<b>Datatype</b>	Contact		
<b>Definition</b>	An association to Customer Accounting Contact.		
<b>See section</b>	G30 3.		

**BuyerContact**

<b>Classname</b>	BuyerContact	<b>Alternative term</b>	
<b>Cardinality</b>	0..1	<b>Usage</b>	Bilateral
<b>Datatype</b>	Contact		
<b>Definition</b>	An association to Buyer Contact.		
<b>See section</b>	G30 3.		

**Excluded classes and fields in BuyerCustomerParty (Statement.BuyerCustomerParty)**

None



### 3.4.1. Statement.BuyerCustomerParty.Party

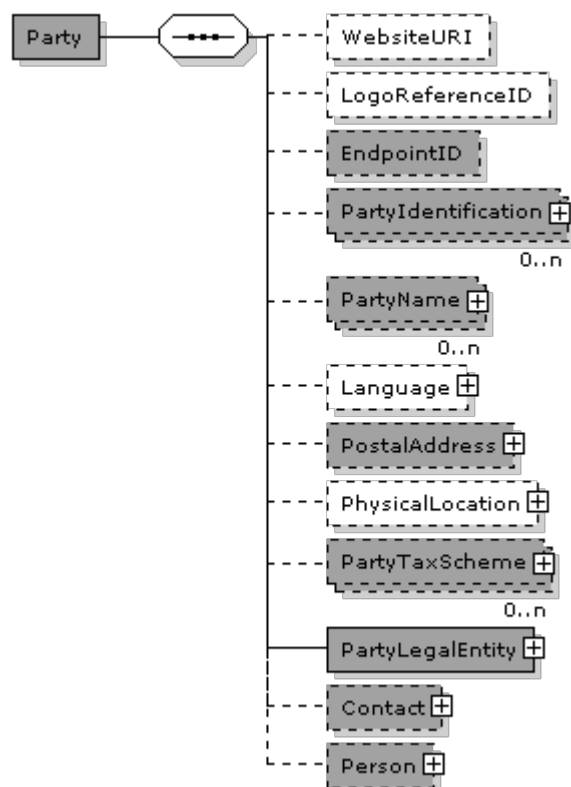

#### Party (Statement.BuyerCustomerParty.Party) specification

<b>Name</b>	Statement.BuyerCustomerParty.Party	<b>Alternative term</b>	OIOUBL_GUIDE_PARTIES
<b>Definition</b>	Information about an organisation, sub-organisation or individual fulfilling a role in a business process		
<b>See also</b>	OIOUBL_GUIDE_PARTIES ( OIO )		

#### Fields

UBL-Name	Name	Datatype	Usage	Cardinality
WebsiteURI	WebsiteURI	Identifier	Bilateral	0..1
LogoReferenceID	LogoReferenceID	Identifier	Bilateral	0..1
EndpointID	EndpointID	Identifier	Yes	0..1

**Subclasses in class Party (Statement.BuyerCustomerParty.Party)**

UBL-Name	Name	Usage	Cardinality	Reference
PartyIdentification	PartyIdentification	Yes	0..n	G30 3.71
PartyName	PartyName	Yes	0..n	G30 3.73
Language	Language	Bilateral	0..1	G30 3.56
PostalAddress	PostalAddress	Yes	0..1	G30 3.1
PhysicalLocation	PhysicalLocation	Bilateral	0..1	G30 3.60
PartyTaxScheme	PartyTaxScheme	Yes	0..n	G30 3.74
PartyLegalEntity	PartyLegalEntity	Yes	1	G30 3.72
Contact	Contact	Yes	0..1	G30 3.21
Person	Person	Yes	0..1	G30 3.79

**Field specifications****WebsiteURI**

Fieldname	WebsiteURI	Alternative term	
Cardinality	0..1	Usage	Bilateral
Datatype	Identifier		
Definition	The Uniform Resource Identifier (URI) of the Party		

**LogoReferenceID**

Fieldname	LogoReferenceID	Alternative term	
Cardinality	0..1	Usage	Bilateral
Datatype	Identifier		
Definition	A Party's logo		

**EndpointID**

Fieldname	EndpointID	Alternative term	OIOUBL_GUIDE_ENDPOINT
Cardinality	0..1	Usage	Yes
Datatype	Identifier		
Definition	Identifies the end point of the routing service, e.g. EAN Location Number, GLN		
Id schemelist	urn:oiubl:scheme:endpointid-1.1		
See also	OIOUBL_GUIDE_ENDPOINT ( OIO )		

**Class Specification****PartyIdentification**

Classname	PartyIdentification	Alternative term	
Cardinality	0..n	Usage	Yes
Datatype	PartyIdentification		
Definition	An association to Party Identification		
See section	G30 3.71		

**PartyName**

Classname	PartyName	Alternative term	
Cardinality	0..n	Usage	Yes
Datatype	PartyName		
Definition	An association to Party Name. Party Name must be used where no Party Identification is used.		
Businessrules	Mandatory if PartyIdentification.ID not used. Only use more than 1 if multilanguage.		
Recommendation	At Header level PartyName should be supplied		
Dependency	../PartyIdentification		
See section	G30 3.73		

**Language**

## 3.4.1. Statement.BuyerCustomerParty.Party

<b>Classname</b>	Language	<b>Alternative term</b>	
<b>Cardinality</b>	0..1	<b>Usage</b>	Bilateral
<b>Datatype</b>	Language		
<b>Definition</b>	An association to Language		
<b>See section</b>	G30 3.56		

**PostalAddress**

<b>Classname</b>	PostalAddress	<b>Alternative term</b>	OIOUBL_GUIDE_ADDRESS
<b>Cardinality</b>	0..1	<b>Usage</b>	Yes
<b>Datatype</b>	Address		
<b>Definition</b>	The Party's postal address		
<b>Recommendation</b>	The Address should be specified on header level and must be of the type StructuredDK.		
<b>See section</b>	G30 3.1		
<b>See also</b>	OIOUBL_GUIDE_ADDRESS ( OIO )		

**PhysicalLocation**

<b>Classname</b>	PhysicalLocation	<b>Alternative term</b>	
<b>Cardinality</b>	0..1	<b>Usage</b>	Bilateral
<b>Datatype</b>	Location		
<b>Definition</b>	The Party's visiting address		
<b>Recommendation</b>	Only if different from PostalAddress		
<b>See section</b>	G30 3.60		

**PartyTaxScheme**

<b>Classname</b>	PartyTaxScheme	<b>Alternative term</b>	OIOUBL_GUIDE_TAX
<b>Cardinality</b>	0..n	<b>Usage</b>	Yes
<b>Datatype</b>	PartyTaxScheme		
<b>Definition</b>	An association to Party Tax Scheme		
<b>See section</b>	G30 3.74		
<b>See also</b>	OIOUBL_GUIDE_TAX ( OIO )		

**PartyLegalEntity**

<b>Classname</b>	PartyLegalEntity	<b>Alternative term</b>	OIOUBL_GUIDE_TAX
<b>Cardinality</b>	1	<b>Usage</b>	Yes
<b>Datatype</b>	PartyLegalEntity		
<b>Definition</b>	An association to Party Legal Entity		
<b>See section</b>	G30 3.72		
<b>See also</b>	OIOUBL_GUIDE_TAX ( OIO )		

**Contact**

<b>Classname</b>	Contact	<b>Alternative term</b>	OIOUBL_GUIDE_CONTACT
<b>Cardinality</b>	0..1	<b>Usage</b>	Yes
<b>Datatype</b>	Contact		
<b>Definition</b>	An association to Contact		
<b>See section</b>	G30 3.21		
<b>See also</b>	OIOUBL_GUIDE_CONTACT ( G23 )		

**Person**

<b>Classname</b>	Person	<b>Alternative term</b>	
<b>Cardinality</b>	0..1	<b>Usage</b>	Yes
<b>Datatype</b>	Person		
<b>Definition</b>	An association to a Person.		
<b>See section</b>	G30 3.79		

**Excluded classes and fields in Party (Statement.BuyerCustomerParty.Party)**

Name	Name	Type
MarkCareIndicator	MarkCareIndicator	Field
MarkAttentionIndicator	MarkAttentionIndicator	Field
AgentParty	AgentParty	Class



### 3.5. Statement.SellerSupplierParty

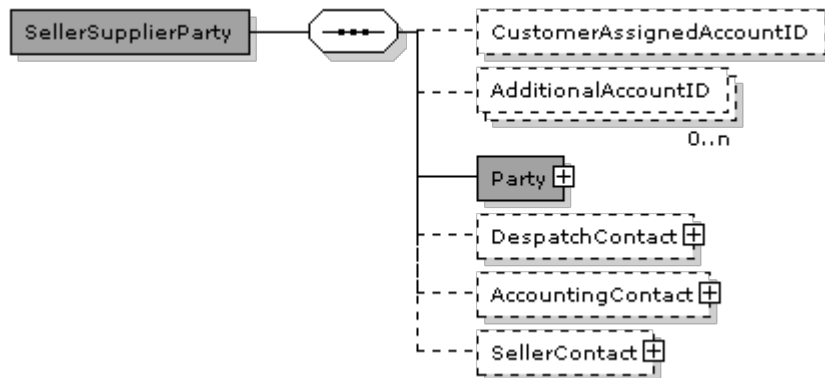

#### SellerSupplierParty (Statement.SellerSupplierParty) specification

<b>Name</b>	Statement.SellerSupplierParty	<b>Alternative term</b>	
<b>Definition</b>	Information about the Supplier Party		

#### Fields

UBL-Name	Name	Datatype	Usage	Cardinality
CustomerAssignedAccountID	CustomerAssignedAccountID	Identifier	Bilateral	0..1
AdditionalAccountID	AdditionalAccountID	Identifier	Bilateral	0..n

#### Subclasses in class SellerSupplierParty (Statement.SellerSupplierParty)

UBL-Name	Name	Usage	Cardi nality	Reference
Party	Party	Yes	1	3.5.1
DespatchContact	DespatchContact	Bilateral	0..1	G30 3.21
AccountingContact	AccountingContact	Bilateral	0..1	G30 3.21
SellerContact	SellerContact	Bilateral	0..1	G30 3.21

#### Field specifications

##### CustomerAssignedAccountID

<b>Fieldname</b>	CustomerAssignedAccountID	<b>Alternative term</b>	
<b>Cardinality</b>	0..1	<b>Usage</b>	Bilateral
<b>Datatype</b>	Identifier		
<b>Definition</b>	An identifier for the Supplier assigned by the Customer; the Customer's internal reference for the Supplier		

##### AdditionalAccountID

<b>Fieldname</b>	AdditionalAccountID	<b>Alternative term</b>	
<b>Cardinality</b>	0..n	<b>Usage</b>	Bilateral
<b>Datatype</b>	Identifier		
<b>Definition</b>	An identifier for the Supplier assigned by a third party		

**Class Specification****Party**

<b>Classname</b>	Party	<b>Alternative term</b>	
<b>Cardinality</b>	1	<b>Usage</b>	Yes
<b>Datatype</b>	Party		
<b>Definition</b>	An association to Party		
<b>See section</b>	3.5.1		

**DespatchContact**

<b>Classname</b>	DespatchContact	<b>Alternative term</b>	
<b>Cardinality</b>	0..1	<b>Usage</b>	Bilateral
<b>Datatype</b>	Contact		
<b>Definition</b>	An association to Despatch		
<b>See section</b>	G30 3.21		

**AccountingContact**

<b>Classname</b>	AccountingContact	<b>Alternative term</b>	
<b>Cardinality</b>	0..1	<b>Usage</b>	Bilateral
<b>Datatype</b>	Contact		
<b>Definition</b>	An association to the Supplier Accounting Contact		
<b>See section</b>	G30 3.21		

**SellerContact**

<b>Classname</b>	SellerContact	<b>Alternative term</b>	
<b>Cardinality</b>	0..1	<b>Usage</b>	Bilateral
<b>Datatype</b>	Contact		
<b>Definition</b>	An association to the Seller		
<b>See section</b>	G30 3.21		

**Excluded classes and fields in SellerSupplierParty (Statement.SellerSupplierParty)**

Name	Name	Type
DataSendingCapability	DataSendingCapability	Field

### 3.5.1. Statement.SellerSupplierParty.Party

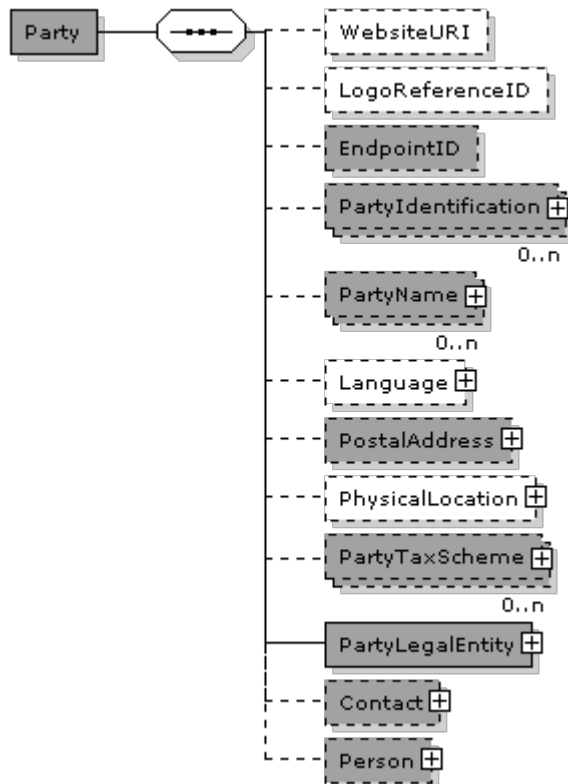

#### Party (Statement.SellerSupplierParty.Party) specification

<b>Name</b>	Statement.SellerSupplierParty.Party	<b>Alternative term</b>	OIOUBL_GUIDE_PARTIES
<b>Definition</b>	Information about an organisation, sub-organisation or individual fulfilling a role in a business process		
<b>See also</b>	OIOUBL_GUIDE_PARTIES ( OIO )		

#### Fields

UBL-Name	Name	Datatype	Usage	Cardinality
WebsiteURI	WebsiteURI	Identifier	Bilateral	0..1
LogoReferenceID	LogoReferenceID	Identifier	Bilateral	0..1
EndpointID	EndpointID	Identifier	Yes	0..1

**Subclasses in class Party (Statement.SellerSupplierParty.Party)**

UBL-Name	Name	Usage	Cardinality	Reference
PartyIdentification	PartyIdentification	Yes	0..n	G30 3.71
PartyName	PartyName	Yes	0..n	G30 3.73
Language	Language	Bilateral	0..1	G30 3.56
PostalAddress	PostalAddress	Yes	0..1	G30 3.1
PhysicalLocation	PhysicalLocation	Bilateral	0..1	G30 3.60
PartyTaxScheme	PartyTaxScheme	Yes	0..n	G30 3.74
PartyLegalEntity	PartyLegalEntity	Yes	1	G30 3.72
Contact	Contact	Yes	0..1	G30 3.21
Person	Person	Yes	0..1	G30 3.79

**Field specifications****WebsiteURI**

Fieldname	WebsiteURI	Alternative term	
Cardinality	0..1	Usage	Bilateral
Datatype	Identifier		
Definition	The Uniform Resource Identifier (URI) of the Party		

**LogoReferenceID**

Fieldname	LogoReferenceID	Alternative term	
Cardinality	0..1	Usage	Bilateral
Datatype	Identifier		
Definition	A Party's logo		

**EndpointID**

Fieldname	EndpointID	Alternative term	OIOUBL_GUIDE_ENDPOINT
Cardinality	0..1	Usage	Yes
Datatype	Identifier		
Definition	Identifies the end point of the routing service, e.g. EAN Location Number, GLN		
Id schemelist	urn:oiubl:scheme:endpointid-1.1		
See also	OIOUBL_GUIDE_ENDPOINT ( OIO )		

**Class Specification****PartyIdentification**

Classname	PartyIdentification	Alternative term	
Cardinality	0..n	Usage	Yes
Datatype	PartyIdentification		
Definition	An association to Party Identification		
See section	G30 3.71		

**PartyName**

Classname	PartyName	Alternative term	
Cardinality	0..n	Usage	Yes
Datatype	PartyName		
Definition	An association to Party Name. Party Name must be used where no Party Identification is used.		
Businessrules	Mandatory if PartyIdentification.ID not used. Only use more than 1 if multilanguage.		
Recommendation	At Header level PartyName should be supplied		
Dependency	../PartyIdentification		
See section	G30 3.73		

**Language**



<b>Classname</b>	Language	<b>Alternative term</b>	
<b>Cardinality</b>	0..1	<b>Usage</b>	Bilateral
<b>Datatype</b>	Language		
<b>Definition</b>	An association to Language		
<b>See section</b>	G30 3.56		

**PostalAddress**

<b>Classname</b>	PostalAddress	<b>Alternative term</b>	OIOUBL_GUIDE_ADDRESS
<b>Cardinality</b>	0..1	<b>Usage</b>	Yes
<b>Datatype</b>	Address		
<b>Definition</b>	The Party's postal address		
<b>Recommendation</b>	The Address should be specified on header level and must be of the type StructuredDK.		
<b>See section</b>	G30 3.1		
<b>See also</b>	OIOUBL_GUIDE_ADDRESS ( OIO )		

**PhysicalLocation**

<b>Classname</b>	PhysicalLocation	<b>Alternative term</b>	
<b>Cardinality</b>	0..1	<b>Usage</b>	Bilateral
<b>Datatype</b>	Location		
<b>Definition</b>	The Party's visiting address		
<b>Recommendation</b>	Only if different from PostalAddress		
<b>See section</b>	G30 3.60		

**PartyTaxScheme**

<b>Classname</b>	PartyTaxScheme	<b>Alternative term</b>	OIOUBL_GUIDE_TAX
<b>Cardinality</b>	0..n	<b>Usage</b>	Yes
<b>Datatype</b>	PartyTaxScheme		
<b>Definition</b>	An association to Party Tax Scheme		
<b>See section</b>	G30 3.74		
<b>See also</b>	OIOUBL_GUIDE_TAX ( OIO )		

**PartyLegalEntity**

<b>Classname</b>	PartyLegalEntity	<b>Alternative term</b>	OIOUBL_GUIDE_TAX
<b>Cardinality</b>	1	<b>Usage</b>	Yes
<b>Datatype</b>	PartyLegalEntity		
<b>Definition</b>	An association to Party Legal Entity		
<b>See section</b>	G30 3.72		
<b>See also</b>	OIOUBL_GUIDE_TAX ( OIO )		

**Contact**

<b>Classname</b>	Contact	<b>Alternative term</b>	OIOUBL_GUIDE_CONTACT
<b>Cardinality</b>	0..1	<b>Usage</b>	Yes
<b>Datatype</b>	Contact		
<b>Definition</b>	An association to Contact		
<b>See section</b>	G30 3.21		
<b>See also</b>	OIOUBL_GUIDE_CONTACT ( G23 )		

**Person**

<b>Classname</b>	Person	<b>Alternative term</b>	
<b>Cardinality</b>	0..1	<b>Usage</b>	Yes
<b>Datatype</b>	Person		
<b>Definition</b>	An association to a Person.		
<b>See section</b>	G30 3.79		

**Excluded classes and fields in Party (Statement.SellerSupplierParty.Party)**

Name	Name	Type
MarkCareIndicator	MarkCareIndicator	Field
MarkAttentionIndicator	MarkAttentionIndicator	Field
AgentParty	AgentParty	Class



### 3.6. Statement.PayeeParty



#### PayeeParty (Statement.PayeeParty) specification

<b>Name</b>	Statement.PayeeParty	<b>Alternative term</b>	
<b>Definition</b>	Information about the Customer Party		

#### Fields

UBL-Name	Name	Datatype	Usage	Cardinality
WebsiteURI	WebsiteURI	Identifier	Bilateral	0..1
LogoReferenceID	LogoReferenceID	Identifier	Bilateral	0..1
EndpointID	EndpointID	Identifier	Yes	0..1

#### Subclasses in class PayeeParty (Statement.PayeeParty)

UBL-Name	Name	Usage	Cardinality	Reference
PartyIdentification	PartyIdentification	Yes	0..n	G30 3.71
PartyName	PartyName	Yes	0..n	G30 3.73
Language	Language	Bilateral	0..1	G30 3.56
PostalAddress	PostalAddress	Yes	0..1	G30 3.1
PhysicalLocation	PhysicalLocation	Bilateral	0..1	G30 3.60
PartyTaxScheme	PartyTaxScheme	Yes	0..n	G30 3.74
PartyLegalEntity	PartyLegalEntity	Yes	1	G30 3.72
Contact	Contact	Yes	0..1	G30 3.21
Person	Person	Yes	0..1	G30 3.79

## Field specifications

### WebsiteURI

<b>Fieldname</b>	WebsiteURI	<b>Alternative term</b>	
<b>Cardinality</b>	0..1	<b>Usage</b>	Bilateral
<b>Datatype</b>	Identifier		
<b>Definition</b>	The Uniform Resource Identifier (URI) of the Party		

### LogoReferenceID

<b>Fieldname</b>	LogoReferenceID	<b>Alternative term</b>	
<b>Cardinality</b>	0..1	<b>Usage</b>	Bilateral
<b>Datatype</b>	Identifier		
<b>Definition</b>	A Party's logo		

### EndpointID

<b>Fieldname</b>	EndpointID	<b>Alternative term</b>	OIOUBL_GUIDE_ENDPOINT
<b>Cardinality</b>	0..1	<b>Usage</b>	Yes
<b>Datatype</b>	Identifier		
<b>Definition</b>	Identifies the end point of the routing service, e.g. EAN Location Number, GLN		
<b>Id schemelist</b>	urn:oiubl:scheme:endpointid-1.1		
<b>See also</b>	OIOUBL_GUIDE_ENDPOINT ( OIO )		

## Class Specification

### PartyIdentification

<b>Classname</b>	PartyIdentification	<b>Alternative term</b>	
<b>Cardinality</b>	0..n	<b>Usage</b>	Yes
<b>Datatype</b>	PartyIdentification		
<b>Definition</b>	An association to Party Identification		
<b>See section</b>	G30 3.71		

### PartyName

<b>Classname</b>	PartyName	<b>Alternative term</b>	
<b>Cardinality</b>	0..n	<b>Usage</b>	Yes
<b>Datatype</b>	PartyName		
<b>Definition</b>	An association to Party Name. Party Name must be used where no Party Identification is used.		
<b>Businessrules</b>	Mandatory if PartyIdentification.ID not used. Only use more than 1 if multilanguage.		
<b>Recommendation</b>	At Header level PartyName should be supplied		
<b>Dependency</b>	../PartyIdentification		
<b>See section</b>	G30 3.73		

### Language

<b>Classname</b>	Language	<b>Alternative term</b>	
<b>Cardinality</b>	0..1	<b>Usage</b>	Bilateral
<b>Datatype</b>	Language		
<b>Definition</b>	An association to Language		
<b>See section</b>	G30 3.56		

### PostalAddress

<b>Classname</b>	PostalAddress	<b>Alternative term</b>	OIOUBL_GUIDE_ADDRESS
<b>Cardinality</b>	0..1	<b>Usage</b>	Yes
<b>Datatype</b>	Address		
<b>Definition</b>	The Party's postal address		
<b>Recommendation</b>	The Address should be specified on header level and must be of the type StructuredDK.		
<b>See section</b>	G30 3.1		
<b>See also</b>	OIOUBL_GUIDE_ADDRESS ( OIO )		

**PhysicalLocation**

<b>Classname</b>	PhysicalLocation	<b>Alternative term</b>	
<b>Cardinality</b>	0..1	<b>Usage</b>	Bilateral
<b>Datatype</b>	Location		
<b>Definition</b>	The Party's visiting address		
<b>Recommendation</b>	Only if different from PostalAddress		
<b>See section</b>	G30 3.60		

**PartyTaxScheme**

<b>Classname</b>	PartyTaxScheme	<b>Alternative term</b>	OIOUBL_GUIDE_TAX
<b>Cardinality</b>	0..n	<b>Usage</b>	Yes
<b>Datatype</b>	PartyTaxScheme		
<b>Definition</b>	An association to Party Tax Scheme		
<b>See section</b>	G30 3.74		
<b>See also</b>	OIOUBL_GUIDE_TAX ( OIO )		

**PartyLegalEntity**

<b>Classname</b>	PartyLegalEntity	<b>Alternative term</b>	OIOUBL_GUIDE_TAX
<b>Cardinality</b>	1	<b>Usage</b>	Yes
<b>Datatype</b>	PartyLegalEntity		
<b>Definition</b>	An association to Party Legal Entity		
<b>See section</b>	G30 3.72		
<b>See also</b>	OIOUBL_GUIDE_TAX ( OIO )		

**Contact**

<b>Classname</b>	Contact	<b>Alternative term</b>	OIOUBL_GUIDE_CONTACT
<b>Cardinality</b>	0..1	<b>Usage</b>	Yes
<b>Datatype</b>	Contact		
<b>Definition</b>	An association to Contact		
<b>See section</b>	G30 3.21		
<b>See also</b>	OIOUBL_GUIDE_CONTACT ( G23 )		

**Person**

<b>Classname</b>	Person	<b>Alternative term</b>	
<b>Cardinality</b>	0..1	<b>Usage</b>	Yes
<b>Datatype</b>	Person		
<b>Definition</b>	An association to a Person.		
<b>See section</b>	G30 3.79		

**Excluded classes and fields in PayeeParty (Statement.PayeeParty)**

Name	Name	Type
MarkCareIndicator	MarkCareIndicator	Field
MarkAttentionIndicator	MarkAttentionIndicator	Field
AgentParty	AgentParty	Class

### 3.7. Statement.AllowanceCharge

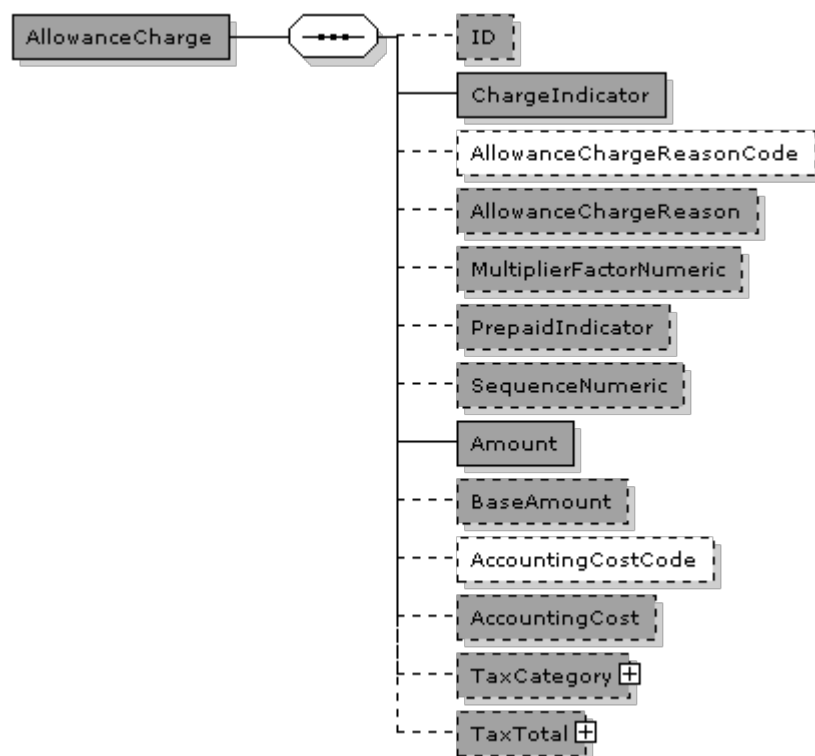

#### AllowanceCharge (Statement.AllowanceCharge) specification

<b>Name</b>	Statement.AllowanceCharge	<b>Alternative term</b>	OIOUBL_GUIDE_ALLOWANCE
<b>Definition</b>	Information about a charge or discount price component		
<b>See also</b>	OIOUBL_GUIDE_ALLOWANCE ( OIO )		

#### Fields

UBL-Name	Name	Datatype	Usage	Cardinality
ID	ID	Identifier	Yes	0..1
ChargeIndicator	ChargeIndicator	Indicator	Yes	1
AllowanceChargeReasonCode	AllowanceChargeReasonCode	Code	Bilateral	0..1
AllowanceChargeReason	AllowanceChargeReason	Text	Yes	0..1
MultiplierFactorNumeric	MultiplierFactorNumeric	Numeric	Yes	0..1
PrepaidIndicator	PrepaidIndicator	Indicator	Yes	0..1
SequenceNumeric	SequenceNumeric	Numeric	Yes	0..1
Amount	Amount	Amount	Yes	1
BaseAmount	BaseAmount	Amount	Yes	0..1
AccountingCostCode	AccountingCostCode	Code	Bilateral	0..1
AccountingCost	AccountingCost	Text	Yes	0..1

**Subclasses in class AllowanceCharge (Statement.AllowanceCharge)**

UBL-Name	Name	Usage	Cardinality	Reference
TaxCategory	TaxCategory	Yes	0..1	G30 3.101
TaxTotal	TaxTotal	Yes	0..1	G30 3.104

## Field specifications

*ID*

<b>Fieldname</b>	ID	<b>Alternative term</b>	
<b>Cardinality</b>	0..1	<b>Usage</b>	Yes
<b>Datatype</b>	Identifier		
<b>Definition</b>	The identifier for the Allowance Charge		
<b>Businessrules</b>	Suppliers reference.		

*ChargeIndicator*

<b>Fieldname</b>	ChargeIndicator	<b>Alternative term</b>	
<b>Cardinality</b>	1	<b>Usage</b>	Yes
<b>Datatype</b>	Indicator		
<b>Definition</b>	Indicates whether the Allowance Charge is a charge (true) or a discount (false)		
<b>Businessrules</b>	Indicates if amount should be added or subtracted. Subtracted if "false".		

*AllowanceChargeReasonCode*

<b>Fieldname</b>	AllowanceChargeReasonCode	<b>Alternative term</b>	
<b>Cardinality</b>	0..1	<b>Usage</b>	Bilateral
<b>Datatype</b>	Code		
<b>Definition</b>	The reason for the Allowance Charge expressed as a code		
<b>Codelist</b>	UN/CEFACT 64465		

*AllowanceChargeReason*

<b>Fieldname</b>	AllowanceChargeReason	<b>Alternative term</b>	
<b>Cardinality</b>	0..1	<b>Usage</b>	Yes
<b>Datatype</b>	Text		
<b>Definition</b>	The reason for the Allowance Charge expressed as text		
<b>Businessrules</b>	Use free text to indicate reason		
<b>Recommendation</b>	Always indicate reason.		

*MultiplierFactorNumeric*

<b>Fieldname</b>	MultiplierFactorNumeric	<b>Alternative term</b>	
<b>Cardinality</b>	0..1	<b>Usage</b>	Yes
<b>Datatype</b>	Numeric		
<b>Definition</b>	The factor applied to the Base Amount to calculate the Allowance Charge		
<b>Businessrules</b>	Use only in conjunction with BaseAmount (used to provide extra information).		
<b>Recommendation</b>	Use factor to 3 decimal places		
<b>Legal values</b>	> 0		

*PrepaidIndicator*

<b>Fieldname</b>	PrepaidIndicator	<b>Alternative term</b>	
<b>Cardinality</b>	0..1	<b>Usage</b>	Yes
<b>Datatype</b>	Indicator		
<b>Definition</b>	Indicates whether the Allowance Charge is prepaid (true) or not (false)		

*SequenceNumeric*

<b>Fieldname</b>	SequenceNumeric	<b>Alternative term</b>	
<b>Cardinality</b>	0..1	<b>Usage</b>	Yes
<b>Datatype</b>	Numeric		
<b>Definition</b>	Identifies the numerical order sequence in which Allowance Charges are calculated when multiple Allowance Charges apply. If all Allowance Charges apply to the same Base Amount, SequenceNumeric will be <input type="checkbox"/> 1 <input type="checkbox"/> for all Allowance Charges		
<b>Businessrules</b>	Used if a calculationsequence is required.		

*Amount*

<b>Fieldname</b>	Amount	<b>Alternative term</b>	
<b>Cardinality</b>	1	<b>Usage</b>	Yes
<b>Datatype</b>	Amount		
<b>Definition</b>	The Allowance Charge amount		



**BaseAmount**

<b>Fieldname</b>	BaseAmount	<b>Alternative term</b>	
<b>Cardinality</b>	0..1	<b>Usage</b>	Yes
<b>Datatype</b>	Amount		
<b>Definition</b>	The amount to which the MultiplierFactorNumeric is applied to calculate the Allowance Charge		
<b>Businessrules</b>	Use only in conjunction with MultiplierFactorNumreic (used to provide extra information).		

**AccountingCostCode**

<b>Fieldname</b>	AccountingCostCode	<b>Alternative term</b>	
<b>Cardinality</b>	0..1	<b>Usage</b>	Bilateral
<b>Datatype</b>	Code		
<b>Definition</b>	The Buyer's accounting code as applied to the Allowance Charge		
<b>Businessrules</b>	Use in standalone invoice and/or required by the buyer. If you have a bilaterally agreement use code.		

**AccountingCost**

<b>Fieldname</b>	AccountingCost	<b>Alternative term</b>	
<b>Cardinality</b>	0..1	<b>Usage</b>	Yes
<b>Datatype</b>	Text		
<b>Definition</b>	The Buyer's accounting center as applied to the Allowance Charge		
<b>Businessrules</b>	Use in standalone invoice and/or required by the buyer. Use it if you have no bilaterally agreement about a code		

**Class Specification****TaxCategory**

<b>Classname</b>	TaxCategory	<b>Alternative term</b>	
<b>Cardinality</b>	0..1	<b>Usage</b>	Yes
<b>Datatype</b>	TaxCategory		
<b>Definition</b>	An association to Tax Category		
<b>See section</b>	G30 3.101		

**TaxTotal**

<b>Classname</b>	TaxTotal	<b>Alternative term</b>	
<b>Cardinality</b>	0..1	<b>Usage</b>	Yes
<b>Datatype</b>	TaxTotal		
<b>Definition</b>	An association to Tax Total		
<b>See section</b>	G30 3.104		

**Excluded classes and fields in AllowanceCharge (Statement.AllowanceCharge)**

Name	Name	Type
PaymentMeans	PaymentMeans	Class

### 3.8. Statement.StatementLine

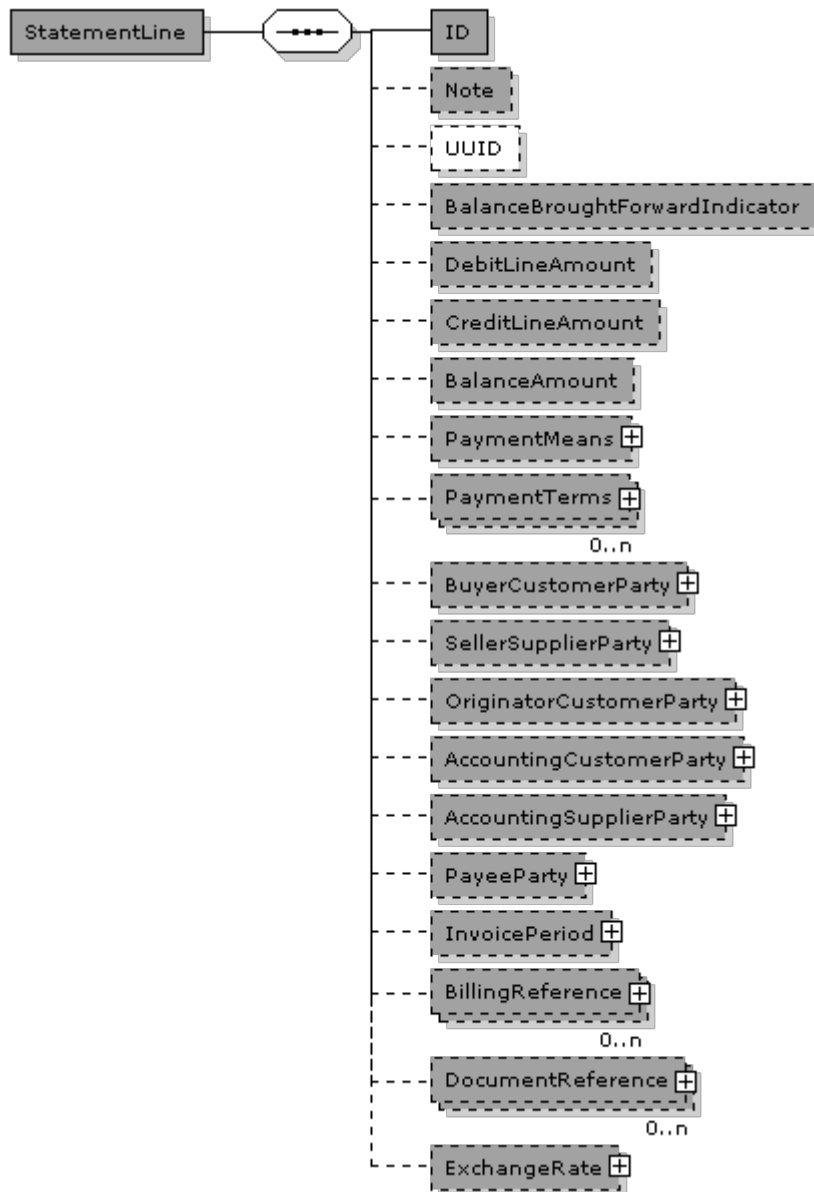

#### StatementLine (Statement.StatementLine) specification

Name	Statement.StatementLine	Alternative term	
Definition	Information about a line in a statement		

**Fields**

UBL-Name	Name	Datatype	Usage	Cardinality
ID	ID	Identifier	Yes	1
Note	Note	Text	Yes	0..1
UUID	UUID	Identifier	Bilateral	0..1
BalanceBroughtForwardIndicator	BalanceBroughtForwardIndicator	Indicator	Yes	0..1
DebitLineAmount	DebitLineAmount	Amount	Yes	0..1
CreditLineAmount	CreditLineAmount	Amount	Yes	0..1
BalanceAmount	BalanceAmount	Amount	Yes	0..1

**Subclasses in class StatementLine (Statement.StatementLine)**

UBL-Name	Name	Usage	Cardinality	Reference
PaymentMeans	PaymentMeans	Yes	0..1	G30 3.76
PaymentTerms	PaymentTerms	Yes	0..n	G30 3.77
BuyerCustomerParty	BuyerCustomerParty	Yes	0..1	G30 3.27
SellerSupplierParty	SellerSupplierParty	Yes	0..1	G30 3.100
OriginatorCustomerParty	OriginatorCustomerParty	Yes	0..1	G30 3.27
AccountingCustomerParty	AccountingCustomerParty	Yes	0..1	G30 3.27
AccountingSupplierParty	AccountingSupplierParty	Yes	0..1	G30 3.100
PayeeParty	PayeeParty	Yes	0..1	G30 3.70
InvoicePeriod	InvoicePeriod	Yes	0..1	G30 3.78
BillingReference	BillingReference	Yes	0..n	3.8.1
DocumentReference	DocumentReference	Yes	0..n	G30 3.36
ExchangeRate	ExchangeRate	Yes	0..1	G30 3.40

## Field specifications

### ID

<b>Fieldname</b>	ID	<b>Alternative term</b>	
<b>Cardinality</b>	1	<b>Usage</b>	Yes
<b>Datatype</b>	Identifier		
<b>Definition</b>	Identification for StatementLine		

### Note

<b>Fieldname</b>	Note	<b>Alternative term</b>	
<b>Cardinality</b>	0..1	<b>Usage</b>	Yes
<b>Datatype</b>	Text		
<b>Definition</b>	Free text form applying to StatementLine. This element may contain notes or any other similar information that is not contained explicitly in another structure.		

### UUID

<b>Fieldname</b>	UUID	<b>Alternative term</b>	
<b>Cardinality</b>	0..1	<b>Usage</b>	Bilateral
<b>Datatype</b>	Identifier		
<b>Definition</b>	A computer-generated universally unique identifier (UUID) for the Statement Line instance		

### BalanceBroughtForwardIndicator

<b>Fieldname</b>	BalanceBroughtForwardIndicator	<b>Alternative term</b>	
<b>Cardinality</b>	0..1	<b>Usage</b>	Yes
<b>Datatype</b>	Indicator		
<b>Definition</b>	Indicates (TRUE) that StatementLine contains a transferred balance		

### DebitLineAmount

<b>Fieldname</b>	DebitLineAmount	<b>Alternative term</b>	
<b>Cardinality</b>	0..1	<b>Usage</b>	Yes
<b>Datatype</b>	Amount		
<b>Definition</b>	The amount debited on StatementLine		
<b>Businessrules</b>	Either Debet or Credit amount is required		
<b>Dependency</b>	../CreditLineAmount		

### CreditLineAmount

<b>Fieldname</b>	CreditLineAmount	<b>Alternative term</b>	
<b>Cardinality</b>	0..1	<b>Usage</b>	Yes
<b>Datatype</b>	Amount		
<b>Definition</b>	The amount credited on StatementLine		
<b>Businessrules</b>	Either Debet or Credit amount is required		
<b>Dependency</b>	../DebitLineAmount		

### BalanceAmount

<b>Fieldname</b>	BalanceAmount	<b>Alternative term</b>	
<b>Cardinality</b>	0..1	<b>Usage</b>	Yes
<b>Datatype</b>	Amount		
<b>Definition</b>	The Balance amount on StatementLine		

## Class Specification

### PaymentMeans

<b>Classname</b>	PaymentMeans	<b>Alternative term</b>	OIOUBL_GUIDE_PAYMENT
<b>Cardinality</b>	0..1	<b>Usage</b>	Yes
<b>Datatype</b>	PaymentMeans		
<b>Definition</b>	An association to Payment Means		
<b>See section</b>	G30 3.76		
<b>See also</b>	OIOUBL_GUIDE_PAYMENT ( OIO )		

### PaymentTerms

<b>Classname</b>	PaymentTerms	<b>Alternative term</b>	OIOUBL_GUIDE_PAYMENT
<b>Cardinality</b>	0..n	<b>Usage</b>	Yes
<b>Datatype</b>	PaymentTerms		
<b>Definition</b>	An association to Payment Terms.		
<b>See section</b>	G30 3.77		
<b>See also</b>	OIOUBL_GUIDE_PAYMENT ( OIO )		

**BuyerCustomerParty**

<b>Classname</b>	BuyerCustomerParty	<b>Alternative term</b>	OIOUBL_GUIDE_PARTIES
<b>Cardinality</b>	0..1	<b>Usage</b>	Yes
<b>Datatype</b>	CustomerParty		
<b>Definition</b>	An association to Buyer		
<b>See section</b>	G30 3.27		
<b>See also</b>	OIOUBL_GUIDE_PARTIES ( OIO )		

**SellerSupplierParty**

<b>Classname</b>	SellerSupplierParty	<b>Alternative term</b>	OIOUBL_GUIDE_PARTIES
<b>Cardinality</b>	0..1	<b>Usage</b>	Yes
<b>Datatype</b>	SupplierParty		
<b>Definition</b>	An association to Seller		
<b>See section</b>	G30 3.100		
<b>See also</b>	OIOUBL_GUIDE_PARTIES ( OIO )		

**OriginatorCustomerParty**

<b>Classname</b>	OriginatorCustomerParty	<b>Alternative term</b>	OIOUBL_GUIDE_PARTIES
<b>Cardinality</b>	0..1	<b>Usage</b>	Yes
<b>Datatype</b>	CustomerParty		
<b>Definition</b>	An association to OriginatorCustomer		
<b>See section</b>	G30 3.27		
<b>See also</b>	OIOUBL_GUIDE_PARTIES ( OIO )		

**AccountingCustomerParty**

<b>Classname</b>	AccountingCustomerParty	<b>Alternative term</b>	OIOUBL_GUIDE_PARTIES
<b>Cardinality</b>	0..1	<b>Usage</b>	Yes
<b>Datatype</b>	CustomerParty		
<b>Definition</b>	An association to AccountingCustomerParty		
<b>See section</b>	G30 3.27		
<b>See also</b>	OIOUBL_GUIDE_PARTIES ( OIO )		

**AccountingSupplierParty**

<b>Classname</b>	AccountingSupplierParty	<b>Alternative term</b>	OIOUBL_GUIDE_PARTIES
<b>Cardinality</b>	0..1	<b>Usage</b>	Yes
<b>Datatype</b>	SupplierParty		
<b>Definition</b>	An association to AccountingSupplierParty		
<b>See section</b>	G30 3.100		
<b>See also</b>	OIOUBL_GUIDE_PARTIES ( OIO )		

**PayeeParty**

<b>Classname</b>	PayeeParty	<b>Alternative term</b>	
<b>Cardinality</b>	0..1	<b>Usage</b>	Yes
<b>Datatype</b>	Party		
<b>Definition</b>	An association to PayeeParty		
<b>See section</b>	G30 3.70		

**InvoicePeriod**

<b>Classname</b>	InvoicePeriod	<b>Alternative term</b>	
<b>Cardinality</b>	0..1	<b>Usage</b>	Yes
<b>Datatype</b>	Period		
<b>Definition</b>	An association to InvoicePeriod		
<b>See section</b>	G30 3.78		

**BillingReference**

<b>Classname</b>	BillingReference	<b>Alternative term</b>	
<b>Cardinality</b>	0..n	<b>Usage</b>	Yes
<b>Datatype</b>	BillingReference		
<b>Definition</b>	An association to BillingReference		
<b>See section</b>	3.8.1		

**DocumentReference**

<b>Classname</b>	DocumentReference	<b>Alternative term</b>	
<b>Cardinality</b>	0..n	<b>Usage</b>	Yes
<b>Datatype</b>	DocumentReference		
<b>Definition</b>	An association to Documentreference to invoice, creditnote, reminder or payment (payment/payout)		
<b>See section</b>	G30 3.36		

**ExchangeRate**

<b>Classname</b>	ExchangeRate	<b>Alternative term</b>	OIOUBL_GUIDE_CURRENC Y
<b>Cardinality</b>	0..1	<b>Usage</b>	Yes
<b>Datatype</b>	ExchangeRate		
<b>Definition</b>	An association to ExchangeRate (between the currency for StatementLine and the currency for the related document)		
<b>See section</b>	G30 3.40		
<b>See also</b>	OIOUBL_GUIDE_CURRENCY ( OIO )		

**Excluded classes and fields in StatementLine (Statement.StatementLine)**

None

### 3.8.1. Statement.StatementLine.BillingReference

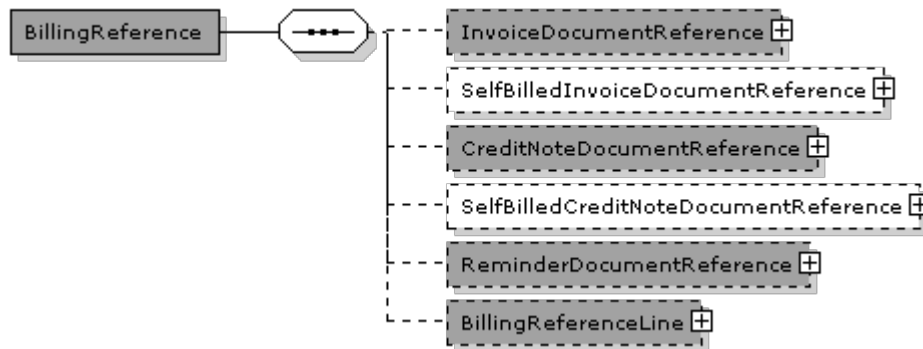

#### BillingReference (Statement.StatementLine.BillingReference) specification

<b>Name</b>	Statement.StatementLine.BillingReference	<b>Alternative term</b>	
<b>Definition</b>	information directly relating to a related document		

#### Fields

None

#### Subclasses in class BillingReference (Statement.StatementLine.BillingReference)

UBL-Name	Name	Usage	Cardinality	Reference
InvoiceDocumentReference	InvoiceDocumentReference	Yes	0..1	3.8.1.1
SelfBilledInvoiceDocumentReference	SelfBilledInvoiceDocumentReference	Bilateral	0..1	3.8.1.2
CreditNoteDocumentReference	CreditNoteDocumentReference	Yes	0..1	3.8.1.3
SelfBilledCreditNoteDocumentReference	SelfBilledCreditNoteDocumentReference	Bilateral	0..1	3.8.1.4
ReminderDocumentReference	ReminderDocumentReference	Yes	0..1	3.8.1.5
BillingReferenceLine	BillingReferenceLine	Yes	0..1	G30 3.7

#### Class Specification

##### InvoiceDocumentReference

<b>Classname</b>	InvoiceDocumentReference	<b>Alternative term</b>	
<b>Cardinality</b>	0..1	<b>Usage</b>	Yes
<b>Datatype</b>	DocumentReference		
<b>Definition</b>	Provides a means of associating a Line (optionally) with one or more invoices which are being related		
<b>See section</b>	3.8.1.1		

##### SelfBilledInvoiceDocumentReference

### 3.8.1. Statement.StatementLine.BillingReference

<b>Classname</b>	SelfBilledInvoiceDocumentReference	<b>Alternative term</b>	
<b>Cardinality</b>	0..1	<b>Usage</b>	Bilateral
<b>Datatype</b>	DocumentReference		
<b>Definition</b>	Provides a means of associating a Line (optionally) with one or more self billed invoices which are being related		
<b>See section</b>	3.8.1.2		

#### **CreditNoteDocumentReference**

<b>Classname</b>	CreditNoteDocumentReference	<b>Alternative term</b>	
<b>Cardinality</b>	0..1	<b>Usage</b>	Yes
<b>Datatype</b>	DocumentReference		
<b>Definition</b>	Provides a means of associating a Line (optionally) with one or more credit notes		
<b>See section</b>	3.8.1.3		

#### **SelfBilledCreditNoteDocumentReference**

<b>Classname</b>	SelfBilledCreditNoteDocumentReference	<b>Alternative term</b>	
<b>Cardinality</b>	0..1	<b>Usage</b>	Bilateral
<b>Datatype</b>	DocumentReference		
<b>Definition</b>	Provides a means of associating a Line (optionally) with one or more self billed credit notes		
<b>See section</b>	3.8.1.4		

#### **ReminderDocumentReference**

<b>Classname</b>	ReminderDocumentReference	<b>Alternative term</b>	
<b>Cardinality</b>	0..1	<b>Usage</b>	Yes
<b>Datatype</b>	DocumentReference		
<b>Definition</b>	Provides a means of associating a Line (optionally) with one or more reminders		
<b>See section</b>	3.8.1.5		

#### **BillingReferenceLine**

<b>Classname</b>	BillingReferenceLine	<b>Alternative term</b>	
<b>Cardinality</b>	0..1	<b>Usage</b>	Yes
<b>Datatype</b>	BillingReferenceLine		
<b>Definition</b>	an association to Billing Reference Line		
<b>See section</b>	G30 3.7		

### Excluded classes and fields in BillingReference (Statement.StatementLine.BillingReference)

Name	Name	Type
DebitNoteDocumentReference	DebitNoteDocumentReference	Class
AdditionalDocumentReference	AdditionalDocumentReference	Class

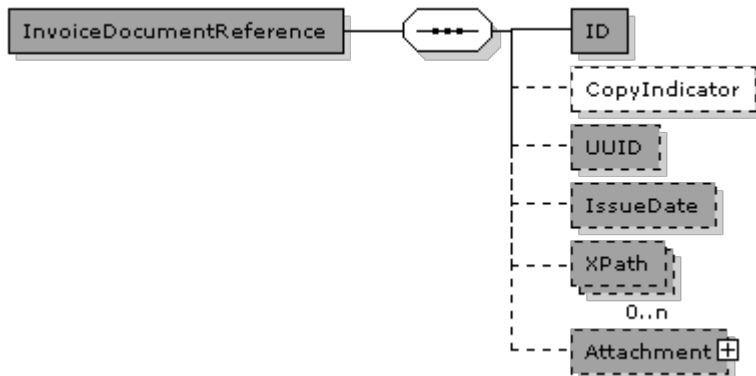

**3.8.1.1.****Statement.StatementLine.BillingReference.InvoiceDocumentReference**
**InvoiceDocumentReference  
 (Statement.StatementLine.BillingReference.InvoiceDocumentReference) specification**

<b>Name</b>	Statement.StatementLine.BillingReference.InvoiceDocumentReference	<b>Alternative term</b>	OIOUBL_GUIDE_DOCUMENTREF
<b>Definition</b>	Information about a Document referred to in another Document		
<b>See also</b>	OIOUBL_GUIDE_DOCUMENTREF ( OIO )		

**Fields**

UBL-Name	Name	Datatype	Usage	Cardinality
ID	ID	Identifier	Yes	1
CopyIndicator	CopyIndicator	Indicator	Bilateral	0..1
UUID	UUID	Identifier	Yes	0..1
IssueDate	IssueDate	Date	Yes	0..1
XPath	XPath	Text	Yes	0..n

**Subclasses in class InvoiceDocumentReference  
 (Statement.StatementLine.BillingReference.InvoiceDocumentReference)**

UBL-Name	Name	Usage	Cardinality	Reference
Attachment	Attachment	Yes	0..1	3.8.1.1.1

**Field specifications****ID**

<b>Fieldname</b>	ID	<b>Alternative term</b>	
<b>Cardinality</b>	1	<b>Usage</b>	Yes
<b>Datatype</b>	Identifier		
<b>Definition</b>	The identifier for the Document being referred to		
<b>Example</b>	428.34		

**CopyIndicator**

<b>Fieldname</b>	CopyIndicator	<b>Alternative term</b>	
<b>Cardinality</b>	0..1	<b>Usage</b>	Bilateral
<b>Datatype</b>	Indicator		
<b>Definition</b>	Indicates whether the referenced Document is a copy (true) or the original (false)		
<b>Example</b>	false		

**UUID**

<b>Fieldname</b>	UUID	<b>Alternative term</b>	OIOUBL_GUIDE_UUID
<b>Cardinality</b>	0..1	<b>Usage</b>	Yes
<b>Datatype</b>	Identifier		
<b>Definition</b>	A computer-generated universally unique identifier (UUID) for the referenced Document instance		
<b>See also</b>	OIOUBL_GUIDE_UUID ( G32 )		

**IssueDate**

<b>Fieldname</b>	IssueDate	<b>Alternative term</b>	
<b>Cardinality</b>	0..1	<b>Usage</b>	Yes
<b>Datatype</b>	Date		
<b>Definition</b>	The date assigned by the sender of the referenced Document on which the referenced Document was issued		
<b>Example</b>	2006-09-01		

**XPath**

<b>Fieldname</b>	XPath	<b>Alternative term</b>	
<b>Cardinality</b>	0..n	<b>Usage</b>	Yes
<b>Datatype</b>	Text		
<b>Definition</b>	Refers to another part of the same document instance		
<b>Example</b>	/DocumentReference[ID='428.22']		

**Class Specification****Attachment**

<b>Classname</b>	Attachment	<b>Alternative term</b>	
<b>Cardinality</b>	0..1	<b>Usage</b>	Yes
<b>Datatype</b>	Attachment		
<b>Definition</b>	An attached document, external referred to, referred in the MIME location or embedded.		
<b>See section</b>	3.8.1.1.1		

**Excluded classes and fields in InvoiceDocumentReference (Statement.StatementLine.BillingReference.InvoiceDocumentReference)**

Name	Name	Type
DocumentTypeCode	DocumentTypeCode	Field
DocumentType	DocumentType	Field

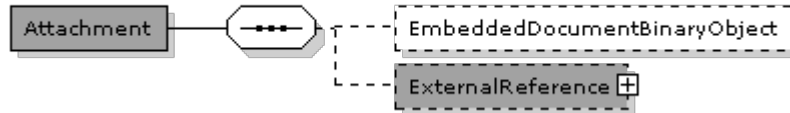
**3.8.1.1.1.****Statement.StatementLine.BillingReference.InvoiceDocumentReference.Attachment****Attachment****(Statement.StatementLine.BillingReference.InvoiceDocumentReference.Attachment) specification**

<b>Name</b>	Statement.StatementLine.BillingReference.InvoiceDocumentReference.Attachment	<b>Alternative term</b>	OIOUBL_GUIDE_ATTACHM ENT
<b>Definition</b>	Information about an attached document. An attachment can be referred to externally (with the URI element), internally (with the MIME reference element) or contained within the document itself (with the EmbeddedDocument element).		
<b>See also</b>	OIOUBL_GUIDE_ATTACHMENT ( OIO )		

**Fields**

UBL-Name	Name	Datatype	Usage	Cardinality
EmbeddedDocumentBinaryObject	EmbeddedDocumentBinaryObject	Binary Object	Bilateral	0..1

**Subclasses in class Attachment****(Statement.StatementLine.BillingReference.InvoiceDocumentReference.Attachment)**

UBL-Name	Name	Usage	Cardi nality	Reference
ExternalReference	ExternalReference	Yes	0..1	G30 3.41

**Field specifications****EmbeddedDocumentBinaryObject**

<b>Fieldname</b>	EmbeddedDocumentBinaryObject	<b>Alternative term</b>	
<b>Cardinality</b>	0..1	<b>Usage</b>	Bilateral
<b>Datatype</b>	Binary Object		
<b>Definition</b>	Contains an embedded document as a BLOB.		
<b>Businessrules</b>	Only allowed if no ExternalReference is specified and if bilateral agreed.		
<b>Dependency</b>	../ExternalReference		

**Class Specification*****ExternalReference***

<b>Classname</b>	ExternalReference	<b>Alternative term</b>	
<b>Cardinality</b>	0..1	<b>Usage</b>	Yes
<b>Datatype</b>	ExternalReference		
<b>Definition</b>	An attached document, external referred to, referred in the MIME location or embedded.		
<b>Businessrules</b>	Used if no EmbeddedDocumentBinaryObject specified		
<b>Dependency</b>	../EmbeddedDocumentBinaryObject		
<b>See section</b>	G30 3.41		

**Excluded classes and fields in Attachment  
(Statement.StatementLine.BillingReference.InvoiceDocumentReference.Attachment)**

None

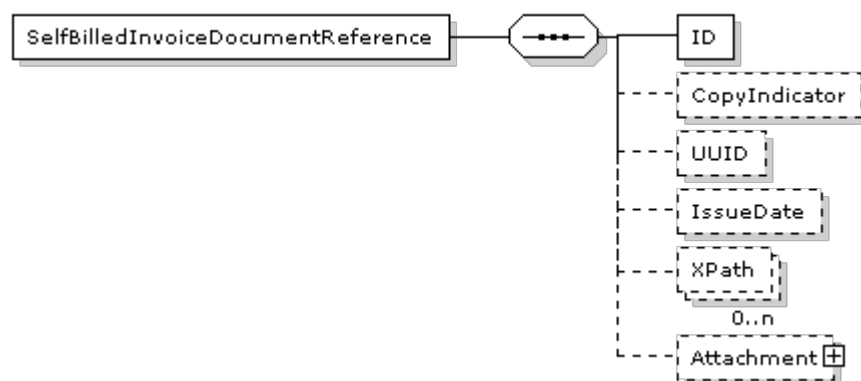
**3.8.1.2.****Statement.StatementLine.BillingReference.SelfBilledInvoiceDocumentReference**

**SelfBilledInvoiceDocumentReference**  
**(Statement.StatementLine.BillingReference.SelfBilledInvoiceDocumentReference)**  
**specification**

<b>Name</b>	Statement.StatementLine.BillingReference.SelfBilledInvoiceDocumentReference	<b>Alternative term</b>	OIOUBL_GUIDE_DOCUMENTREF
<b>Definition</b>	Information about a Document referred to in another Document		
<b>See also</b>	OIOUBL_GUIDE_DOCUMENTREF ( OIO )		

**Fields**

UBL-Name	Name	Datatype	Usage	Cardinality
ID	ID	Identifier	Bilateral	1
CopyIndicator	CopyIndicator	Indicator	Bilateral	0..1
UUID	UUID	Identifier	Bilateral	0..1
IssueDate	IssueDate	Date	Bilateral	0..1
XPath	XPath	Text	Bilateral	0..n

**Subclasses in class SelfBilledInvoiceDocumentReference**  
**(Statement.StatementLine.BillingReference.SelfBilledInvoiceDocumentReference)**

UBL-Name	Name	Usage	Cardinality	Reference
Attachment	Attachment	Bilateral	0..1	3.8.1.2.1

**Field specifications****ID**

<b>Fieldname</b>	ID	<b>Alternative term</b>	
<b>Cardinality</b>	1	<b>Usage</b>	Bilateral
<b>Datatype</b>	Identifier		
<b>Definition</b>	The identifier for the Document being referred to		
<b>Example</b>	428.34		

**CopyIndicator**

<b>Fieldname</b>	CopyIndicator	<b>Alternative term</b>	
<b>Cardinality</b>	0..1	<b>Usage</b>	Bilateral
<b>Datatype</b>	Indicator		
<b>Definition</b>	Indicates whether the referenced Document is a copy (true) or the original (false)		
<b>Example</b>	false		

**UUID**

<b>Fieldname</b>	UUID	<b>Alternative term</b>	OIOUBL_GUIDE_UUID
<b>Cardinality</b>	0..1	<b>Usage</b>	Bilateral
<b>Datatype</b>	Identifier		
<b>Definition</b>	A computer-generated universally unique identifier (UUID) for the referenced Document instance		
<b>See also</b>	OIOUBL_GUIDE_UUID ( G32 )		

**IssueDate**

<b>Fieldname</b>	IssueDate	<b>Alternative term</b>	
<b>Cardinality</b>	0..1	<b>Usage</b>	Bilateral
<b>Datatype</b>	Date		
<b>Definition</b>	The date assigned by the sender of the referenced Document on which the referenced Document was issued		
<b>Example</b>	2006-09-01		

**XPath**

<b>Fieldname</b>	XPath	<b>Alternative term</b>	
<b>Cardinality</b>	0..n	<b>Usage</b>	Bilateral
<b>Datatype</b>	Text		
<b>Definition</b>	Refers to another part of the same document instance		
<b>Example</b>	/DocumentReference[ID='428.22']		

**Class Specification****Attachment**

<b>Classname</b>	Attachment	<b>Alternative term</b>	
<b>Cardinality</b>	0..1	<b>Usage</b>	Bilateral
<b>Datatype</b>	Attachment		
<b>Definition</b>	An attached document, external referred to, referred in the MIME location or embedded.		
<b>See section</b>	3.8.1.2.1		

**Excluded classes and fields in SelfBilledInvoiceDocumentReference (Statement.StatementLine.BillingReference.SelfBilledInvoiceDocumentReference)**

Name	Name	Type
DocumentTypeCode	DocumentTypeCode	Field
DocumentType	DocumentType	Field

### 3.8.1.2.1.

## Statement.StatementLine.BillingReference.SelfBilledInvoiceDocumentReference.Attachment

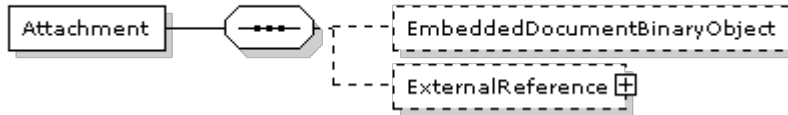

### Attachment

#### (Statement.StatementLine.BillingReference.SelfBilledInvoiceDocumentReference.Attachment) specification

<b>Name</b>	Statement.StatementLine.BillingReference.SelfBilledInvoiceDocumentReference.Attachment	<b>Alternative term</b>	OIOUBL_GUIDE_ATTACHM ENT
<b>Definition</b>	Information about an attached document. An attachment can be referred to externally (with the URI element), internally (with the MIME reference element) or contained within the document itself (with the EmbeddedDocument element).		
<b>See also</b>	OIOUBL_GUIDE_ATTACHM ENT ( OIO )		

### Fields

UBL-Name	Name	Datatype	Usage	Cardinality
EmbeddedDocumentBinaryObject	EmbeddedDocumentBinaryObject	Binary Object	Bilateral	0..1

### Subclasses in class Attachment

#### (Statement.StatementLine.BillingReference.SelfBilledInvoiceDocumentReference.Attachment)

UBL-Name	Name	Usage	Cardinality	Reference
ExternalReference	ExternalReference	Bilateral	0..1	G30 3.41

**Field specifications*****EmbeddedDocumentBinaryObject***

<b>Fieldname</b>	EmbeddedDocumentBinaryObject	<b>Alternative term</b>	
<b>Cardinality</b>	0..1	<b>Usage</b>	Bilateral
<b>Datatype</b>	Binary Object		
<b>Definition</b>	Contains an embedded document as a BLOB,		
<b>Businessrules</b>	Only allowed if no ExternalReference is specified and if bilateral agreed.		
<b>Dependency</b>	../ExternalReference		

**Class Specification*****ExternalReference***

<b>Classname</b>	ExternalReference	<b>Alternative term</b>	
<b>Cardinality</b>	0..1	<b>Usage</b>	Bilateral
<b>Datatype</b>	ExternalReference		
<b>Definition</b>	An attached document, external referred to, referred in the MIME location or embedded.		
<b>Businessrules</b>	Used if no EmbeddedDocumentBinaryObject specified		
<b>Dependency</b>	../EmbeddedDocumentBinaryObject		
<b>See section</b>	G30 3.41		

**Excluded classes and fields in Attachment**

**(Statement.StatementLine.BillingReference.SelfBilledInvoiceDocumentReference.Attachment)**

None

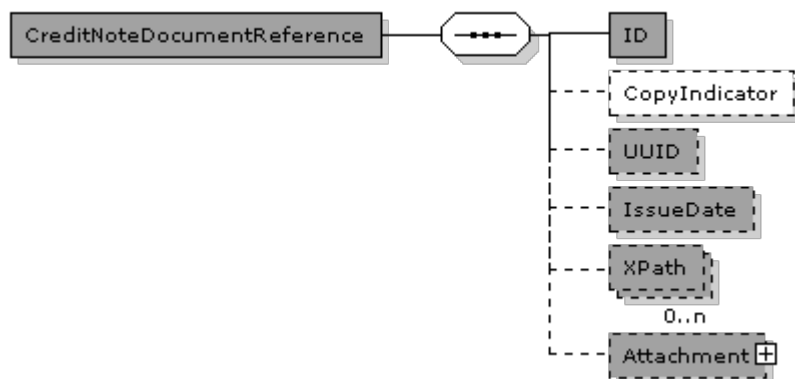

**3.8.1.3.****Statement.StatementLine.BillingReference.CreditNoteDocumentReference****CreditNoteDocumentReference****(Statement.StatementLine.BillingReference.CreditNoteDocumentReference) specification**

<b>Name</b>	Statement.StatementLine.BillingReference.CreditNoteDocumentReference	<b>Alternative term</b>	OIOUBL_GUIDE_DOCUMENTRENTREF
<b>Definition</b>	Information about a Document referred to in another Document		
<b>See also</b>	OIOUBL_GUIDE_DOCUMENTREF ( OIO )		

**Fields**

UBL-Name	Name	Datatype	Usage	Cardinality
ID	ID	Identifier	Yes	1
CopyIndicator	CopyIndicator	Indicator	Bilateral	0..1
UUID	UUID	Identifier	Yes	0..1
IssueDate	IssueDate	Date	Yes	0..1
XPath	XPath	Text	Yes	0..n

**Subclasses in class CreditNoteDocumentReference****(Statement.StatementLine.BillingReference.CreditNoteDocumentReference)**

UBL-Name	Name	Usage	Cardinality	Reference
Attachment	Attachment	Yes	0..1	3.8.1.3.1

**Field specifications****ID**

<b>Fieldname</b>	ID	<b>Alternative term</b>	
<b>Cardinality</b>	1	<b>Usage</b>	Yes
<b>Datatype</b>	Identifier		
<b>Definition</b>	The identifier for the Document being referred to		
<b>Example</b>	428.34		

**CopyIndicator**

<b>Fieldname</b>	CopyIndicator	<b>Alternative term</b>	
<b>Cardinality</b>	0..1	<b>Usage</b>	Bilateral
<b>Datatype</b>	Indicator		
<b>Definition</b>	Indicates whether the referenced Document is a copy (true) or the original (false)		
<b>Example</b>	false		

**UUID**

<b>Fieldname</b>	UUID	<b>Alternative term</b>	OIOUBL_GUIDE_UUID
<b>Cardinality</b>	0..1	<b>Usage</b>	Yes
<b>Datatype</b>	Identifier		
<b>Definition</b>	A computer-generated universally unique identifier (UUID) for the referenced Document instance		
<b>See also</b>	OIOUBL_GUIDE_UUID ( G32 )		

**IssueDate**

<b>Fieldname</b>	IssueDate	<b>Alternative term</b>	
<b>Cardinality</b>	0..1	<b>Usage</b>	Yes
<b>Datatype</b>	Date		
<b>Definition</b>	The date assigned by the sender of the referenced Document on which the referenced Document was issued		
<b>Example</b>	2006-09-01		

**XPath**

<b>Fieldname</b>	XPath	<b>Alternative term</b>	
<b>Cardinality</b>	0..n	<b>Usage</b>	Yes
<b>Datatype</b>	Text		
<b>Definition</b>	Refers to another part of the same document instance		
<b>Example</b>	/DocumentReference[ID='428.22']		

**Class Specification****Attachment**

<b>Classname</b>	Attachment	<b>Alternative term</b>	
<b>Cardinality</b>	0..1	<b>Usage</b>	Yes
<b>Datatype</b>	Attachment		
<b>Definition</b>	An attached document, external referred to, referred in the MIME location or embedded.		
<b>See section</b>	3.8.1.3.1		

**Excluded classes and fields in CreditNoteDocumentReference  
(Statement.StatementLine.BillingReference.CreditNoteDocumentReference)**

Name	Name	Type
DocumentTypeCode	DocumentTypeCode	Field
DocumentType	DocumentType	Field

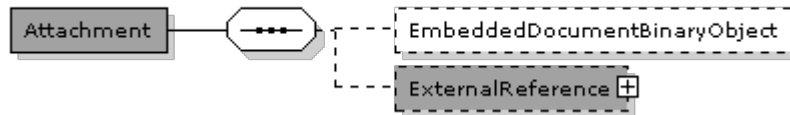
**3.8.1.3.1.****Statement.StatementLine.BillingReference.CreditNoteDocumentReference.Attachment****Attachment****(Statement.StatementLine.BillingReference.CreditNoteDocumentReference.Attachment) specification**

<b>Name</b>	Statement.StatementLine.BillingReference.CreditNoteDocumentReference.Attachment	<b>Alternative term</b>	OIOUBL_GUIDE_ATTACHM ENT
<b>Definition</b>	Information about an attached document. An attachment can be referred to externally (with the URI element), internally (with the MIME reference element) or contained within the document itself (with the EmbeddedDocument element).		
<b>See also</b>	OIOUBL_GUIDE_ATTACHMENT ( OIO )		

**Fields**

UBL-Name	Name	Datatype	Usage	Cardinality
EmbeddedDocumentBinaryObject	EmbeddedDocumentBinaryObject	Binary Object	Bilateral	0..1

**Subclasses in class Attachment****(Statement.StatementLine.BillingReference.CreditNoteDocumentReference.Attachment)**

UBL-Name	Name	Usage	Cardi nality	Reference
ExternalReference	ExternalReference	Yes	0..1	G30 3.41

**Field specifications****EmbeddedDocumentBinaryObject**

<b>Fieldname</b>	EmbeddedDocumentBinaryObject	<b>Alternative term</b>	
<b>Cardinality</b>	0..1	<b>Usage</b>	Bilateral
<b>Datatype</b>	Binary Object		
<b>Definition</b>	Contains an embedded document as a BLOB.		
<b>Businessrules</b>	Only allowed if no ExternalReference is specified and if bilateral agreed.		
<b>Dependency</b>	../ExternalReference		

**Class Specification****ExternalReference**

<b>Classname</b>	ExternalReference	<b>Alternative term</b>	
<b>Cardinality</b>	0..1	<b>Usage</b>	Yes
<b>Datatype</b>	ExternalReference		
<b>Definition</b>	An attached document, external referred to, referred in the MIME location or embedded.		
<b>Businessrules</b>	Used if no EmbeddedDocumentBinaryObject specified		
<b>Dependency</b>	../EmbeddedDocumentBinaryObject		
<b>See section</b>	G30 3.41		

**Excluded classes and fields in Attachment  
(Statement.StatementLine.BillingReference.CreditNoteDocumentReference.Attachment)**

None

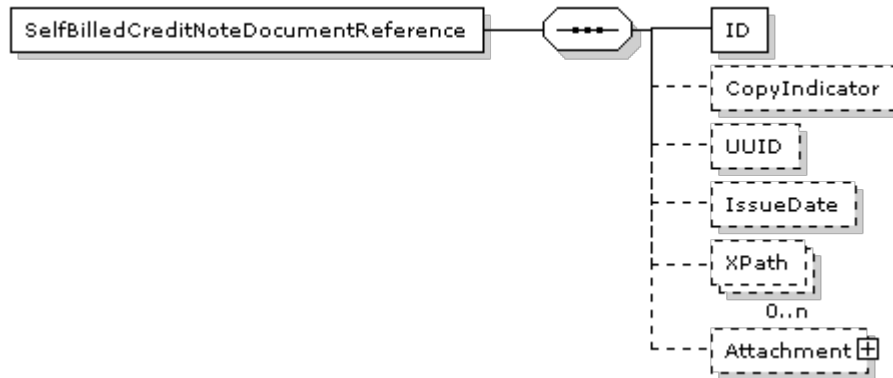
**3.8.1.4.****Statement.StatementLine.BillingReference.SelfBilledCreditNoteDocumentReference****SelfBilledCreditNoteDocumentReference****(Statement.StatementLine.BillingReference.SelfBilledCreditNoteDocumentReference)****specification**

<b>Name</b>	Statement.StatementLine.BillingReference.SelfBilledCreditNoteDocumentReference	<b>Alternative term</b>	OIOUBL_GUIDE_DOCUMENTREF
<b>Definition</b>	Information about a Document referred to in another Document		
<b>See also</b>	OIOUBL_GUIDE_DOCUMENTREF ( OIO )		

**Fields**

UBL-Name	Name	Datatype	Usage	Cardinality
ID	ID	Identifier	Bilateral	1
CopyIndicator	CopyIndicator	Indicator	Bilateral	0..1
UUID	UUID	Identifier	Bilateral	0..1
IssueDate	IssueDate	Date	Bilateral	0..1
XPath	XPath	Text	Bilateral	0..n

**Subclasses in class SelfBilledCreditNoteDocumentReference****(Statement.StatementLine.BillingReference.SelfBilledCreditNoteDocumentReference)**

UBL-Name	Name	Usage	Cardinality	Reference
Attachment	Attachment	Bilateral	0..1	3.8.1.4.1

**Field specifications****ID**

<b>Fieldname</b>	ID	<b>Alternative term</b>	
<b>Cardinality</b>	1	<b>Usage</b>	Bilateral
<b>Datatype</b>	Identifier		
<b>Definition</b>	The identifier for the Document being referred to		
<b>Example</b>	428.34		

**CopyIndicator**

<b>Fieldname</b>	CopyIndicator	<b>Alternative term</b>	
<b>Cardinality</b>	0..1	<b>Usage</b>	Bilateral
<b>Datatype</b>	Indicator		
<b>Definition</b>	Indicates whether the referenced Document is a copy (true) or the original (false)		
<b>Example</b>	false		

**UUID**

<b>Fieldname</b>	UUID	<b>Alternative term</b>	OIOUBL_GUIDE_UUID
<b>Cardinality</b>	0..1	<b>Usage</b>	Bilateral
<b>Datatype</b>	Identifier		
<b>Definition</b>	A computer-generated universally unique identifier (UUID) for the referenced Document instance		
<b>See also</b>	OIOUBL_GUIDE_UUID ( G32 )		

**IssueDate**

<b>Fieldname</b>	IssueDate	<b>Alternative term</b>	
<b>Cardinality</b>	0..1	<b>Usage</b>	Bilateral
<b>Datatype</b>	Date		
<b>Definition</b>	The date assigned by the sender of the referenced Document on which the referenced Document was issued		
<b>Example</b>	2006-09-01		

**XPath**

<b>Fieldname</b>	XPath	<b>Alternative term</b>	
<b>Cardinality</b>	0..n	<b>Usage</b>	Bilateral
<b>Datatype</b>	Text		
<b>Definition</b>	Refers to another part of the same document instance		
<b>Example</b>	/DocumentReference[ID='428.22']		

**Class Specification****Attachment**

<b>Classname</b>	Attachment	<b>Alternative term</b>	
<b>Cardinality</b>	0..1	<b>Usage</b>	Bilateral
<b>Datatype</b>	Attachment		
<b>Definition</b>	An attached document, external referred to, referred in the MIME location or embedded.		
<b>See section</b>	3.8.1.4.1		

**Excluded classes and fields in SelfBilledCreditNoteDocumentReference (Statement.StatementLine.BillingReference.SelfBilledCreditNoteDocumentReference)**

Name	Name	Type
DocumentTypeCode	DocumentTypeCode	Field
DocumentType	DocumentType	Field

### 3.8.1.4.1.

## Statement.StatementLine.BillingReference.SelfBilledCreditNoteDocumentReference.Attachment

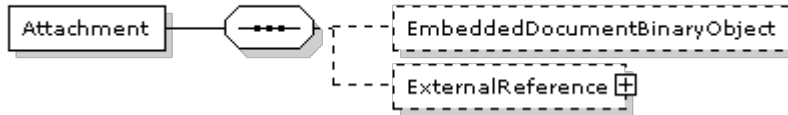

### Attachment

#### (Statement.StatementLine.BillingReference.SelfBilledCreditNoteDocumentReference.Attachment) specification

<b>Name</b>	Statement.StatementLine.BillingReference.SelfBilledCreditNoteDocumentReference.Attachment	<b>Alternative term</b>	OIOUBL_GUIDE_ATTACHM ENT
<b>Definition</b>	Information about an attached document. An attachment can be referred to externally (with the URI element), internally (with the MIME reference element) or contained within the document itself (with the EmbeddedDocument element).		
<b>See also</b>	OIOUBL_GUIDE_ATTACHM ENT ( OIO )		

### Fields

UBL-Name	Name	Datatype	Usage	Cardinality
EmbeddedDocumentBinaryObject	EmbeddedDocumentBinaryObject	Binary Object	Bilateral	0..1

### Subclasses in class Attachment

#### (Statement.StatementLine.BillingReference.SelfBilledCreditNoteDocumentReference.Attachment)

UBL-Name	Name	Usage	Cardinality	Reference
ExternalReference	ExternalReference	Bilateral	0..1	G30 3.41

**Field specifications*****EmbeddedDocumentBinaryObject***

<b>Fieldname</b>	EmbeddedDocumentBinaryObject	<b>Alternative term</b>	
<b>Cardinality</b>	0..1	<b>Usage</b>	Bilateral
<b>Datatype</b>	Binary Object		
<b>Definition</b>	Contains an embedded document as a BLOB,		
<b>Businessrules</b>	Only allowed if no ExternalReference is specified and if bilateral agreed.		
<b>Dependency</b>	../ExternalReference		

**Class Specification*****ExternalReference***

<b>Classname</b>	ExternalReference	<b>Alternative term</b>	
<b>Cardinality</b>	0..1	<b>Usage</b>	Bilateral
<b>Datatype</b>	ExternalReference		
<b>Definition</b>	An attached document, external referred to, referred in the MIME location or embedded.		
<b>Businessrules</b>	Used if no EmbeddedDocumentBinaryObject specified		
<b>Dependency</b>	../EmbeddedDocumentBinaryObject		
<b>See section</b>	G30 3.41		

**Excluded classes and fields in Attachment**

**(Statement.StatementLine.BillingReference.SelfBilledCreditNoteDocumentReference.Attachment)**

None

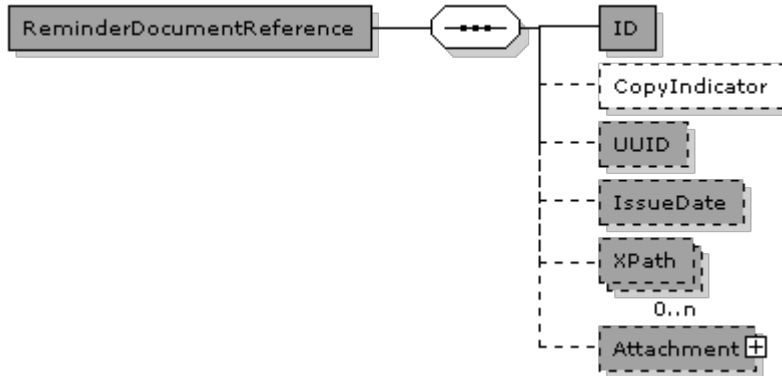

**3.8.1.5.****Statement.StatementLine.BillingReference.ReminderDocumentReference****ReminderDocumentReference****(Statement.StatementLine.BillingReference.ReminderDocumentReference) specification**

<b>Name</b>	Statement.StatementLine.BillingReference.ReminderDocumentReference	<b>Alternative term</b>	OIOUBL_GUIDE_DOCUMENTRENTREF
<b>Definition</b>	Information about a Document referred to in another Document		
<b>See also</b>	OIOUBL_GUIDE_DOCUMENTREF ( OIO )		

**Fields**

UBL-Name	Name	Datatype	Usage	Cardinality
ID	ID	Identifier	Yes	1
CopyIndicator	CopyIndicator	Indicator	Bilateral	0..1
UUID	UUID	Identifier	Yes	0..1
IssueDate	IssueDate	Date	Yes	0..1
XPath	XPath	Text	Yes	0..n

**Subclasses in class ReminderDocumentReference****(Statement.StatementLine.BillingReference.ReminderDocumentReference)**

UBL-Name	Name	Usage	Cardinality	Reference
Attachment	Attachment	Yes	0..1	3.8.1.5.1

**Field specifications****ID**

<b>Fieldname</b>	ID	<b>Alternative term</b>	
<b>Cardinality</b>	1	<b>Usage</b>	Yes
<b>Datatype</b>	Identifier		
<b>Definition</b>	The identifier for the Document being referred to		
<b>Example</b>	428.34		

**CopyIndicator**

<b>Fieldname</b>	CopyIndicator	<b>Alternative term</b>	
<b>Cardinality</b>	0..1	<b>Usage</b>	Bilateral
<b>Datatype</b>	Indicator		
<b>Definition</b>	Indicates whether the referenced Document is a copy (true) or the original (false)		
<b>Example</b>	false		

**UUID**

<b>Fieldname</b>	UUID	<b>Alternative term</b>	OIOUBL_GUIDE_UUID
<b>Cardinality</b>	0..1	<b>Usage</b>	Yes
<b>Datatype</b>	Identifier		
<b>Definition</b>	A computer-generated universally unique identifier (UUID) for the referenced Document instance		
<b>See also</b>	OIOUBL_GUIDE_UUID ( G32 )		

**IssueDate**

<b>Fieldname</b>	IssueDate	<b>Alternative term</b>	
<b>Cardinality</b>	0..1	<b>Usage</b>	Yes
<b>Datatype</b>	Date		
<b>Definition</b>	The date assigned by the sender of the referenced Document on which the referenced Document was issued		
<b>Example</b>	2006-09-01		

**XPath**

<b>Fieldname</b>	XPath	<b>Alternative term</b>	
<b>Cardinality</b>	0..n	<b>Usage</b>	Yes
<b>Datatype</b>	Text		
<b>Definition</b>	Refers to another part of the same document instance		
<b>Example</b>	/DocumentReference[ID='428.22']		

**Class Specification****Attachment**

<b>Classname</b>	Attachment	<b>Alternative term</b>	
<b>Cardinality</b>	0..1	<b>Usage</b>	Yes
<b>Datatype</b>	Attachment		
<b>Definition</b>	An attached document, external referred to, referred in the MIME location or embedded.		
<b>See section</b>	3.8.1.5.1		

**Excluded classes and fields in ReminderDocumentReference (Statement.StatementLine.BillingReference.ReminderDocumentReference)**

Name	Name	Type
DocumentTypeCode	DocumentTypeCode	Field
DocumentType	DocumentType	Field

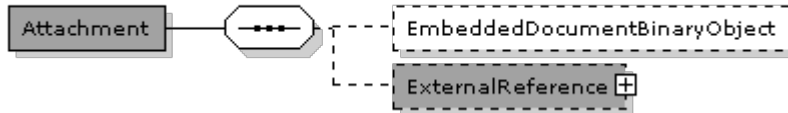
**3.8.1.5.1.****Statement.StatementLine.BillingReference.ReminderDocumentReference.Attachment**

**Attachment**  
**(Statement.StatementLine.BillingReference.ReminderDocumentReference.Attachment)**  
**specification**

<b>Name</b>	Statement.StatementLine.BillingReference.ReminderDocumentReference.Attachment	<b>Alternative term</b>	OIOUBL_GUIDE_ATTACHMENT
<b>Definition</b>	Information about an attached document. An attachment can be referred to externally (with the URI element), internally (with the MIME reference element) or contained within the document itself (with the EmbeddedDocument element).		
<b>See also</b>	OIOUBL_GUIDE_ATTACHMENT ( OIO )		

**Fields**

UBL-Name	Name	Datatype	Usage	Cardinality
EmbeddedDocumentBinaryObject	EmbeddedDocumentBinaryObject	Binary Object	Bilateral	0..1

**Subclasses in class Attachment**  
**(Statement.StatementLine.BillingReference.ReminderDocumentReference.Attachment)**

UBL-Name	Name	Usage	Cardinality	Reference
ExternalReference	ExternalReference	Yes	0..1	G30 3.41

**Field specifications****EmbeddedDocumentBinaryObject**

<b>Fieldname</b>	EmbeddedDocumentBinaryObject	<b>Alternative term</b>	
<b>Cardinality</b>	0..1	<b>Usage</b>	Bilateral
<b>Datatype</b>	Binary Object		
<b>Definition</b>	Contains an embedded document as a BLOB.		
<b>Businessrules</b>	Only allowed if no ExternalReference is specified and if bilateral agreed.		
<b>Dependency</b>	../ExternalReference		

**Class Specification****ExternalReference**

<b>Classname</b>	ExternalReference	<b>Alternative term</b>	
<b>Cardinality</b>	0..1	<b>Usage</b>	Yes
<b>Datatype</b>	ExternalReference		
<b>Definition</b>	An attached document, external referred to, referred in the MIME location or embedded.		
<b>Businessrules</b>	Used if no EmbeddedDocumentBinaryObject specified		
<b>Dependency</b>	../EmbeddedDocumentBinaryObject		
<b>See section</b>	G30 3.41		

**Excluded classes and fields in Attachment  
(Statement.StatementLine.BillingReference.ReminderDocumentReference.Attachment)**

None