



IT- og Telestyrelsen

Ministeriet for Videnskab
Teknologi og Udvikling

OIOUBL Guideline

OIOUBL CatalogueItemSpecificationUpdate

UBL 2.0 CatalogueItemSpecificationUpdate

G06

Version 1.1



This release is protected by Creative Commons License, Naming 2.5 

Colophon

Contact:

National IT and Telecom Agency

E-mail: oioubl@itst.dk

:

April 2007
Ministry of Science, Technology and Innovation
National IT and Telecom Agency

Data Standardization Office
Holsteinsgade 63
DK-2100 Copenhagen Ø
Phone +45 3545 0000
Fax +45 3545 0010
<http://www.itst.dk>
itst@itst.dk

Copyrights for this release in accordance with Creative Common, Naming 2.5:

Permission is granted to:

- *produce processed works based on this document*
- *reproduce and make the document available to the public*
- *use the document for commercial purposes*
provided that the Danish National IT & Telecom Agency be clearly referenced as the source of this release.

Further information about these rights is available at <http://creativecommons.org/licenses/by/2.5/deed.da>.

Contents

1. How to read this document.....	4
1.1 Structure of this document.....	4
1.2 Figure definitions	4
1.3 Term definitions	4
1.4 References.....	5
2. How to fill in OIOUBL document instances.....	6
2.1 Namespace.....	7
2.2 Comments.....	7
2.3 Process instructions.....	8
2.4 Relations to instances of other customizations.....	8
2.5 Code example.....	8
3. CatalogueItemSpecificationUpdate.....	9
3.1. CatalogueItemSpecificationUpdate.....	10
3.2. CatalogueItemSpecificationUpdate.RelatedCatalogueReference.....	16
3.3. CatalogueItemSpecificationUpdate.ReferencedContract.....	19
3.3.1. CatalogueItemSpecificationUpdate.ReferencedContract.ContractDocumentReference.....	22
3.3.1.1. CatalogueItemSpecificationUpdate.ReferencedContract.ContractDocumentReference.Attachment.....	24
3.4. CatalogueItemSpecificationUpdate.ProviderParty.....	26
3.5. CatalogueItemSpecificationUpdate.ReceiverParty.....	30
3.6. CatalogueItemSpecificationUpdate.CatalogueItemSpecificationUpdateLine.....	34
3.6.1. CatalogueItemSpecificationUpdate.CatalogueItemSpecificationUpdateLine.Item.....	36
3.6.1.1. CatalogueItemSpecificationUpdate.CatalogueItemSpecificationUpdateLine.Item.BuyersItemIdentification	42
3.6.1.2. CatalogueItemSpecificationUpdate.CatalogueItemSpecificationUpdateLine.Item.SellersItemIdentification	44
3.6.1.2.1. CatalogueItemSpecificationUpdate.CatalogueItemSpecificationUpdateLine.Item.SellersItemIdentification.PhysicalAttribute.....	46
3.6.1.2.2. CatalogueItemSpecificationUpdate.CatalogueItemSpecificationUpdateLine.Item.SellersItemIdentification.MeasurementDimension.....	48
3.6.1.3. CatalogueItemSpecificationUpdate.CatalogueItemSpecificationUpdateLine.Item.ManufacturersItemIdentification	50
3.6.1.4. CatalogueItemSpecificationUpdate.CatalogueItemSpecificationUpdateLine.Item.StandardItemIdentification.....	52
3.6.1.5. CatalogueItemSpecificationUpdate.CatalogueItemSpecificationUpdateLine.Item.CatalogueItemIdentification.....	54
3.6.1.6. CatalogueItemSpecificationUpdate.CatalogueItemSpecificationUpdateLine.Item.AdditionalItemIdentification.....	56
3.6.1.7. CatalogueItemSpecificationUpdate.CatalogueItemSpecificationUpdateLine.Item.CatalogueDocumentReference.....	58
3.6.1.7.1. CatalogueItemSpecificationUpdate.CatalogueItemSpecificationUpdateLine.Item.CatalogueDocumentReference.Attachment.....	60
3.6.1.8. CatalogueItemSpecificationUpdate.CatalogueItemSpecificationUpdateLine.Item.ItemSpecificationDocumentReference.....	62
3.6.1.9. CatalogueItemSpecificationUpdate.CatalogueItemSpecificationUpdateLine.Item.CommodityClassification.....	65
3.6.1.10. CatalogueItemSpecificationUpdate.CatalogueItemSpecificationUpdateLine.Item.AdditionalItemProperty	67
3.6.1.10.1. CatalogueItemSpecificationUpdate.CatalogueItemSpecificationUpdateLine.Item.AdditionalItemProperty.ItemPropertyGroup.....	69

1. How to read this document

This guideline covers the use of an invoice in OIOUBL. The guideline must be read in correlation with the remaining documents included in the OIOUBL package.

1.1 Structure of this document

This document should be seen as the normative description of an invoice. In case of any conflict, the most specific description will always apply. For example, the description on the lines of a specific element takes precedence of the description at document level. Hence, the descriptions at document level are default values for the lines. The examples in this document and related common guidelines should be seen as descriptive. The guideline text takes precedence of the figures.

The document includes a reading instruction, a description of how to fill in document instances, as well as the actual class specification. The actual specification is composed of:

- A figure showing the class elements that are included in OIOUBL.
- A text specification of the class.
- A list of the UBL elements that from a business perspective make no sense in the specific context.
- A list of the fields that are included in the class.
- A list of the sub-classes that are included in the class.
- A table of key data such as definitions, names, references, and business rules for each of the class fields.
- A table of key data such as definitions, names, references, and business rules for the sub-classes of the class.
- For each of the sub-classes that is used differently that described in the class library, OIOUBL_GUIDE_LIBRARY (ref 30), a subsection contains a corresponding specification. Hence, the sub-classes that have been included in the specification are not selected based on relevance, but solely based on whether they deviate from the general definition of the library.

1.2 Figure definitions

In the class specifications, the class is shown as schema documentation.

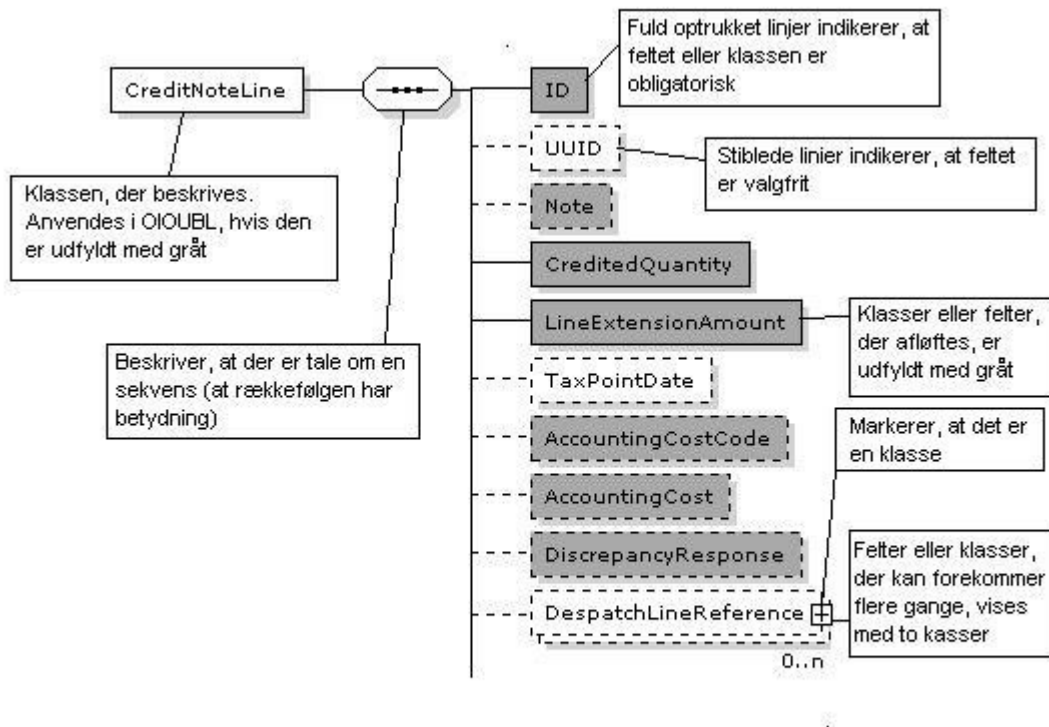

1.3 Term definitions

In this specification, the following terms will be used in the tables:

	Term	Explanation
UBL name		The name that is found in the UBL 2.0 schemas
DK-name		The name in Danish
Use		Describes the cardinality, i.e. the rule describing how many instances of the business information entity are allowed: [1] specifies that one and only one instance is allowed. [0..1] means that the business information entity is optional. [0..n] means that null to infinity instances may occur. [1..n] means that no less than one instance to an infinite number of instances may occur.
Alternative term		Specifies a term which is also used to describe the business information entity.
Used		Determines whether the receiver should be expected to be able to decode the described business information, if it is attached. Information that is not used may still, however, be used upon bilateral agreement.
Business rule		Describes the rules that are attached to the business information entity. Business rules are normative, and will be part of the validation of the document in question.
Recommended		Specifies that common practice requires the described business information entity to be attached. This is a

non-normative guide to the use of the business information entity.

Allowed values:

Describes the value set that the business information entity should conform with.

Codelist

Refers to the codelist that the value set should be found in.

Class

A structure of coherent business information.

1.4 References

In this document reference is made to other documents within the OIOUBL package.

Filnavn	Titel	Ref
OIOUBL_GUIDE_INTRO	Introduktion til OIOUBL Guidelines	G01
Documentguidelines		
OIOUBL_GUIDE_APPRESPONSE	UBL 2.0 ApplicationResponse	G02
OIOUBL_GUIDE_CATALOGUE	UBL 2.0 Catalogue	G03
OIOUBL_GUIDE_CATALOGUEREQUEST	UBL 2.0 CatalogueRequest	G04
OIOUBL_GUIDE_CATALOGUEDELETION	UBL 2.0 CatalogueDeletion	G05
OIOUBL_GUIDE_CATALOGUEITEMSPECIFICATIONUPDATE	UBL 2.0 CatalogueItemSpecificationUpdate	G06
OIOUBL_GUIDE_CATALOGUEPRICINGUPDATE	UBL 2.0 CataloguePricingUpdate	G07
OIOUBL_GUIDE_ORDER	UBL 2.0 Order	G08
OIOUBL_GUIDE_ORDERRESPONSE	UBL 2.0 OrderResponse	G09
OIOUBL_GUIDE_ORDRERESPONSESIMPLE	UBL 2.0 OrdreResponseSimple	G10
OIOUBL_GUIDE_ORDERCHANGE	UBL 2.0 OrderChange	G11
OIOUBL_GUIDE_ORDERCANCELLATION	UBL 2.0 OrderCancellation	G12
OIOUBL_GUIDE_CREDITNOTE	UBL 2.0 CreditNote	G13
OIOUBL_GUIDE_REMINDER	UBL 2.0 Reminder	G14
OIOUBL_GUIDE_STATEMENT	UBL 2.0 Statement	G15
OIOUBL_GUIDE_INVOICE	UBL 2.0 Invoice	G16
Common guidelines		
OIOUBL_GUIDE_ALLOWANCECHARGE	UBL 2.0 AllowanceCharge	G17
OIOUBL_GUIDE_CURRENCYEXCHANGERATES	UBL 2.0 CurrencyExchangeRates	G18
OIOUBL_GUIDE_DELIVERY	UBL 2.0 Delivery and Delivery Party	G19
OIOUBL_GUIDE_DELIVERYTERMS	OIOUBL Leveringsbetingelser - UBL 2.0 Delivery Terms	G20
OIOUBL_GUIDE_DOCUMENTREF	OIOUBL Dokumentreference - UBL 2.0 Document Reference	G21
OIOUBL_GUIDE_ENDPOINTS	OIOUBL EndepunktID - UBL 2.0 Endpoints	G22
OIOUBL_GUIDE_PARTY	OIOUBL Part - UBL 2.0 Party	G23
OIOUBL_GUIDE_BETALING	OIOUBL Betalingsmåder og betingelser - UBL 2.0 Payment means og payment terms	G24
OIOUBL_GUIDE_PRISER	OIOUBL Priser - UBL 2.0 Prices	G25
OIOUBL_GUIDE_PROFILER	OIOUBL Profiler - UBL 2.0 Profiles	G26
OIOUBL_GUIDE_SKAT	OIOUBL Skat - UBL 2.0 Tax	G27
OIOUBL_GUIDE_TOTALER	OIOUBL Totaler - UBL 2.0 Totals	G28
OIOUBL_GUIDE_DATATYPER	OIOUBL Datatyper - UBL 2.0 Datatypes	G29
OIOUBL_GUIDE_BIBLIOTEK	OIOUBL Fælles klassebibliotek - UBL 2.0 CommonLibrary	G30
OIOUBL_GUIDE_SIGNATUR	OIOUBL Signatur - UBL 2.0 Signature	G31
OIOUBL_GUIDE_UUID	OIOUBL UUID - UBL 2.0 UUID	G32
OIOUBL_GUIDE_UDVIDELSER	OIOUBL Udvidelse - UBL 2.0 Extension	G33

OIOUBL_GUIDE_KONTAKT	OIOUBL Kontakt - UBL 2.0 Contact	G34
OIOUBL_GUIDE_RESPONS	OIOUBL Bekræftelse - UBL 2.0 Respons	G35
OIOUBL_GUIDE_ADRESSER	OIOUBL Adresser - UBL 2.0 Adress	G36
Katalogspecifikke tværgående guidelines		
OIOUBL_GUIDE_KATALOG_ID	OIOUBL Identifikation, versionering og gyldighedsperioder i kataloger	G37
OIOUBL_GUIDE_KATALOG_VAREBESKRIV	OIOUBL Varebeskrivelser og kategorisering i kataloger	G38
OIOUBL_GUIDE_KATALOG_PARTER	OIOUBL Parter i kataloger	G39
OIOUBL_GUIDE_KATALOG_PRISER	OIOUBL Pris og mængde i kataloger	G40
Scenarie pakker		
OIOUBL_SCENARIE_INTRO	Introduction to OIOUBL Procurement Scenarios	S01
OIOUBL_SCENARIE_ADVORD	OIOUBL ADVORD - Advanced Ordering Procurement Cycle	S02
OIOUBL_SCENARIE_BASPRO	OIOUBL BASPRO - Basic procurement Cycle	S03
OIOUBL_SCENARIE_CATEXE	OIOUBL CATEXE - Catalogue Exchange	S04
OIOUBL_SCENARIE_COMDEL	OIOUBL COMDEL - Complex Delivery Procurement Cycle	S05
OIOUBL_SCENARIE_COMORG	OIOUBL COMORG - Complex Organisations Procurement Cycle	S06
OIOUBL_SCENARIE_COMPAY	OIOUBL COMPAY - Complex Payment Cycle	S07

2. How to fill in OIOUBL document instances

An Invoice must follow the related UBL schema, and conform to the rules of this guideline. The instances follow the W3C XML specifications, which means that, unless otherwise stated, the normal XML rules apply. It is therefore recommended that an xml encoder is used for reading the documents.

2.1 Namespace

A Namespace is a semantic space in which names are unique and attached to a specific interpretation.

Namespaces often occur as libraries, and may be referenced via an alias-variable. The expression:

```
<... xmlns:cac="urn:oasis:names:specification:ubl:schema:xsd:CommonAggregateComponents-2" ...>
```

means that elements with the prefix “cac” (alias variable) belongs to the “... CommonAggregateComponents-2” namespace. The namespace that is referenced by the actual document is

indicated by “xmlns=...”, i.e. without an alias variable. It is recommended to use the alias variables that are specified in UBL, but this is not a requirement. For an OIOUBL document instance to be validated the following namespaces must be specified:

Alias variable	Namespace
	urn:oasis:names:specification:ubl:schema:xsd:Invoice-2
cac	urn:oasis:names:specification:ubl:schema:xsd:CommonAggregateComponents-2
ccts	urn:oasis:names:specification:ubl:schema:xsd:CoreComponentParameters-2
cbc	urn:oasis:names:specification:ubl:schema:xsd:CommonBasicComponents-2
sdt	urn:oasis:names:specification:ubl:schema:xsd:SpecializedDatatypes-2
udt	urn:un:unece:uncefact:data:specification:UnqualifiedDataTypesSchemaModule:2
ext	urn:oasis:names:specification:ubl:schema:xsd:CommonExtensionComponents-2
xsi	http://www.w3.org/2001/XMLSchema-instance

2.2 Comments

Comments may be used in document instances to facilitate any manual processing of the document. This is particularly relevant during the introduction phase of new systems that use OIOUBL. For those who wish to formalize these comments, we recommend the Dublin-Core metadata definitions, see ”

<http://dublincore.org/documents/dcmi-terms/>". The following terms are used in the examples of the scenario descriptions [S01-S07] :

DC-Term	Description	Example
Title	Describes the title of the document instance	BASPRO_01_01_00_Invoice_v2p0.xml
Replaces	Reference to the preceding instance	BASPRO_01_01_00_Invoice_v0p1.xml
Publisher	Describes who is responsible for the document instance.	"IT og Telestyrelsen"
Creator	Describes the person or the system that created the instance.	"OIOERP v 1.0.2 release 34"
Created	Date (and possibly time) of the creation of the document.	2006-09-08
Modified	Date (and possibly time) when the document was last modified.	2006-09-08
Issued	Date (and possibly time) when it was issued.	2006-09-08
ConformsTo	Description of the context that it belongs to.	OIOUBL_ScenarioPackage_BASPRO
Description	General description	"This document is produced as part of the OIOUBL Basic procurement scenario package"
Rights	Any copyrights that apply to the instance.	"It can be used following the Common Creative License"

Only use meta data that you consider applicable, and only enter valid data. From the above list we particularly recommend using the "Creator" term, as this may ease the troubleshooting at the receiver's system. Comments should be specified within the root element of the document.

2.3 Process instructions

Process instructions are instructions that are not covered by the OIOUBL standard, but which may be used for controlling other logics. For example, when specifying that an instance is used for test purposes. A process instruction is specified by "☐☑☒☓☔☕☖☗☘☙☚☛☜☝☞☟☠☡☢☣☤☥☦☧☨☩☪☫☬☭☮☯☰☱☲☳☴☵☶☷☸☹☺☻☼☽☾☿☽☿" and may contain attributes as shown in the example below. Process instructions should be specified within the root element of the document.

```
<?TestInstance
  ResponseTo="smtp:test@company.dk"
  description= "apply your comment here"
?>
```

2.4 Relations to instances of other customizations

An instance is specified as being OIOUBL by entering "CustomizationID" as "OIOUBL-2.0". OIOUBL instances are built upon UBL 2.0, and may therefore be interpreted directly by UBL 2.0 readers. Instances from other UBL 2.0-customizations can be read directly by OIOUBL readers by changing the "CustomizationID", provided the instance conforms to the requirements of this guideline.

2.5 Code example

Code examples are available in the scenario descriptions [S01-S07]

3. CatalogueItemSpecificationUpdate

3.1. CatalogueItemSpecificationUpdate

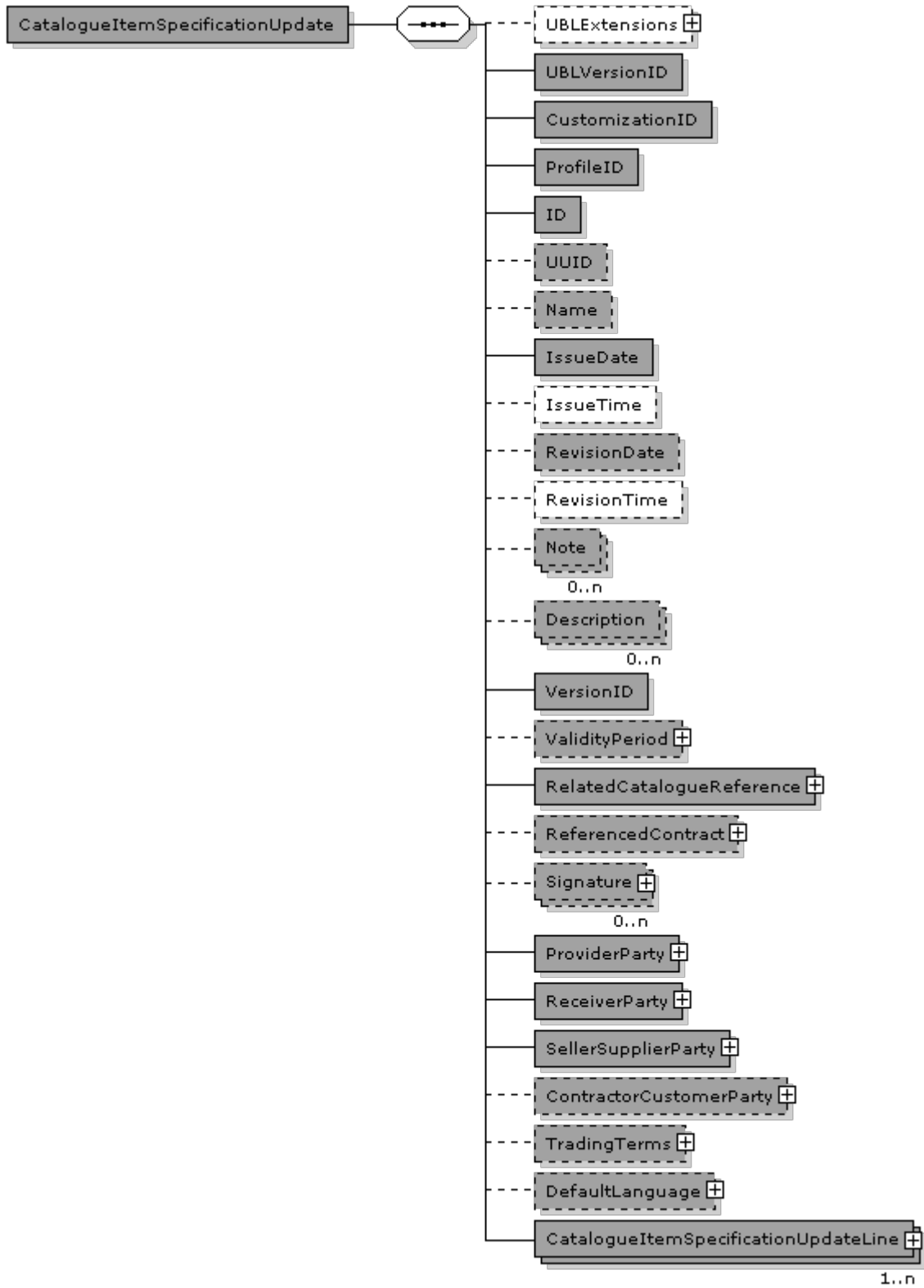

CatalogueItemSpecificationUpdate specification

Name	CatalogueItemSpecificationUpdate	Alternative term	
Definition	The document used to update information about Items (e.g., technical descriptions and properties) on an existing Catalogue.		

Fields

UBL-Name	Name	Datatype	Usage	Cardinality
UBLVersionID	UBLVersionID	Identifier	Yes	1
CustomizationID	CustomizationID	Identifier	Yes	1
ProfileID	ProfileID	Identifier	Yes	1
ID	ID	Identifier	Yes	1
UUID	UUID	Identifier	Yes	0..1
Name	Name	Name	Yes	0..1
IssueDate	IssueDate	Date	Yes	1
IssueTime	IssueTime	Time	Bilateral	0..1
RevisionDate	RevisionDate	Date	Yes	0..1
RevisionTime	RevisionTime	Time	Bilateral	0..1
Note	Note	Text	Yes	0..n
Description	Description	Text	Yes	0..n
VersionID	VersionID	Identifier	Yes	1

Subclasses in class CatalogueItemSpecificationUpdate

UBL-Name	Name	Usage	Cardinality	Reference
UBLExtensions	UBLExtensions	Bilateral	0..1	G22
ValidityPeriod	ValidityPeriod	Yes	0..1	G37
RelatedCatalogueReference	RelatedCatalogueReference	Yes	1	3.2
ReferencedContract	ReferencedContract	Yes	0..1	3.3
Signature	Signature	Yes	0..n	
ProviderParty	ProviderParty	Yes	1	3.4
ReceiverParty	ReceiverParty	Yes	1	3.5
SellerSupplierParty	SellerSupplierParty	Yes	1	G30 3.100
ContractorCustomerParty	ContractorCustomerParty	Yes	0..1	G30 3.27
TradingTerms	TradingTerms	Yes	0..1	
DefaultLanguage	DefaultLanguage	Yes	0..1	
CatalogueItemSpecificationUpdateLine	CatalogueItemSpecificationUpdateLine	Yes	1..n	3.6

Field specifications

UBLVersionID

Fieldname	UBLVersionID	Alternative term	
Cardinality	1	Usage	Yes
Datatype	Identifier		
Definition	The earliest version of the UBL 2 schema for this document type that defines all of the elements that might be encountered in the current instance.		
Legal values	2.0		
Example	2.0		

CustomizationID

Fieldname	CustomizationID	Alternative term	
Cardinality	1	Usage	Yes
Datatype	Identifier		
Definition	Identifies a user-defined customization of UBL for a specific use.		
Legal values	OIOUBL-2.01		

ProfileID

Fieldname	ProfileID	Alternative term	OIOUBL_GUIDE_PROFILES
Cardinality	1	Usage	Yes
Datatype	Identifier		
Definition	Identifies a user-defined profile of the subset of UBL being used.		
Id list	urn:oiubl:id:profileid-1.1		
See also	OIOUBL_GUIDE_PROFILES (OIO)		
Example	Catalogue-CatAdv-1.0		

ID

Fieldname	ID	Alternative term	OIOUBL_GUIDE_CATALOGUE_ID
Cardinality	1	Usage	Yes
Datatype	Identifier		
Definition	An identifier for the Catalogue Revision assigned by the Seller.		
See also	OIOUBL_GUIDE_CATALOGUE_ID (OIO)		

UUID

Fieldname	UUID	Alternative term	OIOUBL_GUIDE_UUID
Cardinality	0..1	Usage	Yes
Datatype	Identifier		
Definition	A computer-generated universally unique identifier (UUID) for the Catalogue Revision instance.		
See also	OIOUBL_GUIDE_UUID (G32)		

Name

Fieldname	Name	Alternative term	
Cardinality	0..1	Usage	Yes
Datatype	Name		
Definition	A name given to the Catalogue Revision.		

IssueDate

Fieldname	IssueDate	Alternative term	
Cardinality	1	Usage	Yes
Datatype	Date		
Definition	The date when the Catalogue Revision was issued.		
Legal values	yyyy-mm-dd		
Example	2006-08-01		

IssueTime

3.1. CatalogueItemSpecificationUpdate

Fieldname	IssueTime	Alternative term	
Cardinality	0..1	Usage	Bilateral
Datatype	Time		
Definition	The time when the Catalogue Revision was issued.		
Legal values	hh:mm:ss		
Example	12:00:00		

RevisionDate

Fieldname	RevisionDate	Alternative term	
Cardinality	0..1	Usage	Yes
Datatype	Date		
Definition	The date assigned by the Seller at which the Catalogue was revised.		
Legal values	yyyy-mm-dd		
Example	2006-08-01		

RevisionTime

Fieldname	RevisionTime	Alternative term	
Cardinality	0..1	Usage	Bilateral
Datatype	Time		
Definition	The time assigned by the Seller at which the Catalogue was revised.		
Legal values	hh:mm:ss		
Example	12:00:00		

Note

Fieldname	Note	Alternative term	
Cardinality	0..n	Usage	Yes
Datatype	Text		
Definition	Free-form text applying to the Catalogue Revision. This element may contain notes or any other similar information that is not contained explicitly in another structure.		
Recommendation	Only one Note per language		

Description

Fieldname	Description	Alternative term	
Cardinality	0..n	Usage	Yes
Datatype	Text		
Definition	A description of the Catalogue Revision.		
Recommendation	Only one Description per language		

VersionID

Fieldname	VersionID	Alternative term	OIOUBL_GUIDE_CATALOG UE_ID
Cardinality	1	Usage	Yes
Datatype	Identifier		
Definition	Indicates the current version of the Catalogue Revision.		
Recommendation	Should be used		
See also	OIOUBL_GUIDE_CATALOGUE_ID (OIO)		
Example	2.1		

Class Specification

ValidityPeriod

Classname	ValidityPeriod	Alternative term	OIOUBL_GUIDE_CATALOG UE_ID
Cardinality	0..1	Usage	Yes
Datatype	Period		
Definition	The period assigned by the Seller during which the information in the Catalogue Revision is effective. This may be given as start and end dates or a duration.		
Businessrules	Note that the ValidityPeriod specified on headerlevel of the CatalogueItemSpecificationUpdate will change the ValidityPeriod for the whole Catalogue.		
See section	G30 3.		
See also	OIOUBL_GUIDE_CATALOGUE_ID (OIO)		

RelatedCatalogueReference

Classname	RelatedCatalogueReference	Alternative term	
Cardinality	1	Usage	Yes
Datatype	CatalogueReference		
Definition	An association to the Catalogue containing the revised Items.		
See section	3.2		

ReferencedContract

Classname	ReferencedContract	Alternative term	
Cardinality	0..1	Usage	Yes
Datatype	Contract		
Definition	An association to a framework agreement or contract.		
See section	3.3		

Signature

Classname	Signature	Alternative term	
Cardinality	0..n	Usage	Yes
Datatype	Signature		
Definition	One or more signatures applied to the document.		
See section	G30 3.		

ProviderParty

Classname	ProviderParty	Alternative term	OIOUBL_GUIDE_CATALOGUE_PARTIES
Cardinality	1	Usage	Yes
Datatype	Party		
Definition	An association to the Catalogue Provider Party.		
Businessrules	The Provider can be a supplier or a third party catalogue administrator		
See section	3.4		
See also	OIOUBL_GUIDE_CATALOGUE_PARTIES (OIO)		

ReceiverParty

Classname	ReceiverParty	Alternative term	OIOUBL_GUIDE_CATALOGUE_PARTIES
Cardinality	1	Usage	Yes
Datatype	Party		
Definition	An association to the Catalogue Receiver Party.		
Businessrules	The Receiver can be a buyer or a third party catalogue administrator e.g. a marketplace or a portal		
See section	3.5		
See also	OIOUBL_GUIDE_CATALOGUE_PARTIES (OIO)		

SellerSupplierParty

Classname	SellerSupplierParty	Alternative term	OIOUBL_GUIDE_CATALOGUE_PARTIES
Cardinality	1	Usage	Yes
Datatype	SupplierParty		
Definition	The Seller Party responsible for the contract to which the Catalogue relates.		
Businessrules	Is default value for CatalogueLine if the party is not specified on the line. Note that a SellerSupplierParty on the line overrules the SellerSupplierParty on the header		
See section	G30 3.100		
See also	OIOUBL_GUIDE_CATALOGUE_PARTIES (OIO)		

ContractorCustomerParty

Classname	ContractorCustomerParty	Alternative term	OIOUBL_GUIDE_CATALOGUE_PARTIES
Cardinality	0..1	Usage	Yes
Datatype	CustomerParty		
Definition	The Customer Party responsible for the contract to which the Catalogue relates.		
Businessrules	Only used when different from ReceiverParty. Is default value for CatalogueLine if the party is not specified on the line.		
See section	G30 3.27		
See also	OIOUBL_GUIDE_CATALOGUE_PARTIES (OIO)		

TradingTerms

Classname	TradingTerms	Alternative term	
Cardinality	0..1	Usage	Yes
Datatype	TradingTerms		
Definition	An association to trading terms.		
Businessrules	Note that the TradingTerms specified on headerlevel of the CatalogueItemSpecificationUpdate will change the TradingTerms for the whole Catalogue. Are the TradingTerms not specified here or in a contract, the TradingTerms on the Order are applicable.		
See section	G30 3.		

DefaultLanguage

Classname	DefaultLanguage	Alternative term	
Cardinality	0..1	Usage	Yes
Datatype	Language		
Definition	The default language for the item specifications.		
See section	G30 3.		

CatalogueItemSpecificationUpdateLine

Classname	CatalogueItemSpecificationUpdateLine	Alternative term	
Cardinality	1..n	Usage	Yes
Datatype	CatalogueItemSpecificationUpdateLine		
Definition	An association to one or more Catalogue Item Specification Update Lines.		
See section	3.6		

Excluded classes and fields in CatalogueItemSpecificationUpdate

Name	Name	Type
LineCountNumeric	LineCountNumeric	Field

3.2. CatalogueItemSpecificationUpdate.RelatedCatalogueReference

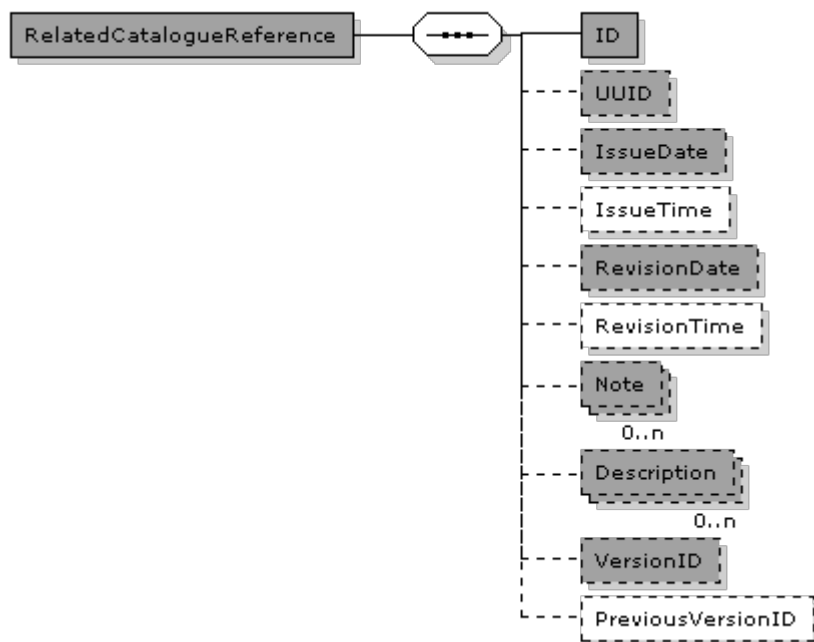

RelatedCatalogueReference (CatalogueItemSpecificationUpdate.RelatedCatalogueReference) specification

Name	CatalogueItemSpecificationUpdate.RelatedCatalogueReference	Alternative term	
Definition	Reference to a Catalogue		

Fields

UBL-Name	Name	Datatype	Usage	Cardinality
ID	ID	Identifier	Yes	1
UUID	UUID	Identifier	Yes	0..1
IssueDate	IssueDate	Date	Yes	0..1
IssueTime	IssueTime	Time	Bilateral	0..1
RevisionDate	RevisionDate	Date	Yes	0..1
RevisionTime	RevisionTime	Time	Bilateral	0..1
Note	Note	Text	Yes	0..n
Description	Description	Text	Yes	0..n
VersionID	VersionID	Identifier	Yes	0..1
PreviousVersionID	PreviousVersionID	Identifier	Bilateral	0..1

Subclasses in class RelatedCatalogueReference (CatalogueItemSpecificationUpdate.RelatedCatalogueReference)

None

Field specifications

ID

Fieldname	ID	Alternative term	
Cardinality	1	Usage	Yes
Datatype	Identifier		
Definition	An identifier for the Catalogue assigned by the Seller		

UUID

Fieldname	UUID	Alternative term	
Cardinality	0..1	Usage	Yes
Datatype	Identifier		
Definition	A computer-generated universally unique identifier (UUID) for the Catalogue instance		

IssueDate

Fieldname	IssueDate	Alternative term	
Cardinality	0..1	Usage	Yes
Datatype	Date		
Definition	The date when the catalogue was published		
Legal values	yyyy-mm-dd		
Example	2007-01-01		

IssueTime

Fieldname	IssueTime	Alternative term	
Cardinality	0..1	Usage	Bilateral
Datatype	Time		
Definition	The time when the catalogue was published		
Legal values	hh:mm:ss		
Example	12:00:00		

RevisionDate

Fieldname	RevisionDate	Alternative term	
Cardinality	0..1	Usage	Yes
Datatype	Date		
Definition	The date (assigned by the Seller Party) at which the information in the catalogue was revised.		
Legal values	yyyy-mm-dd		
Example	2007-01-01		

RevisionTime

Fieldname	RevisionTime	Alternative term	
Cardinality	0..1	Usage	Bilateral
Datatype	Time		
Definition	The time (assigned by the Seller Party) at which the information in the catalogue was revised.		
Legal values	hh:mm:ss		
Example	12:00:00		

Note

Fieldname	Note	Alternative term	
Cardinality	0..n	Usage	Yes
Datatype	Text		
Definition	Free form text applying to the Catalogue. Used for human-readable information		
Recommendation	Only one Note per language		

Description

Fieldname	Description	Alternative term	
Cardinality	0..n	Usage	Yes
Datatype	Text		
Definition	A description of the catalogue		
Recommendation	Only one Description per language		

3.2. CatalogueItemSpecificationUpdate.RelatedCatalogueReference

VersionID

Fieldname	VersionID	Alternative term	
Cardinality	0..1	Usage	Yes
Datatype	Identifier		
Definition	To indicate the current version of the catalogue		
Example	1.2		

PreviousVersionID

Fieldname	PreviousVersionID	Alternative term	
Cardinality	0..1	Usage	Bilateral
Datatype	Identifier		
Definition	Identifies the previous version of the Catalogue which is superceded by this version		

Excluded classes and fields in RelatedCatalogueReference (CatalogueItemSpecificationUpdate.RelatedCatalogueReference)

None

3.3. CatalogueItemSpecificationUpdate.ReferencedContract

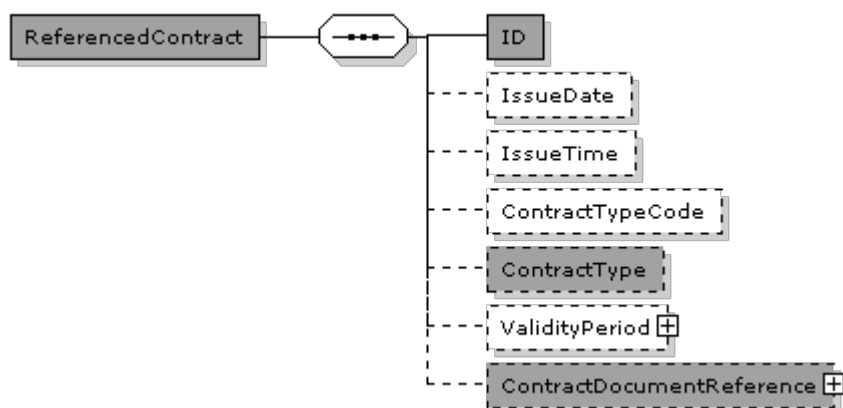

ReferencedContract (CatalogueItemSpecificationUpdate.ReferencedContract) specification

Name	CatalogueItemSpecificationUpdate.ReferencedContract	Alternative term	
Definition	Information about a Contract		
Businessrules	Used for specification of a potential framework agreement		

Fields

UBL-Name	Name	Datatype	Usage	Cardinality
ID	ID	Identifier	Yes	1
IssueDate	IssueDate	Date	Bilateral	0..1
IssueTime	IssueTime	Time	Bilateral	0..1
ContractTypeCode	ContractTypeCode	Code	Bilateral	0..1
ContractType	ContractType	Text	Yes	0..1

Subclasses in class ReferencedContract (CatalogueItemSpecificationUpdate.ReferencedContract)

UBL-Name	Name	Usage	Cardinality	Reference
ValidityPeriod	ValidityPeriod	Bilateral	0..1	G30 3.78
ContractDocumentReference	ContractDocumentReference	Yes	0..1	3.3.1

Field specifications

ID

Fieldname	ID	Alternative term	
Cardinality	1	Usage	Yes
Datatype	Identifier		
Definition	Identification for Contract		
Businessrules	An identifier known by relevant parties		

IssueDate

Fieldname	IssueDate	Alternative term	
Cardinality	0..1	Usage	Bilateral
Datatype	Date		
Definition	Issue date for Contract		

IssueTime

Fieldname	IssueTime	Alternative term	
Cardinality	0..1	Usage	Bilateral
Datatype	Time		
Definition	Issue time for Contract		

ContractTypeCode

Fieldname	ContractTypeCode	Alternative term	
Cardinality	0..1	Usage	Bilateral
Datatype	Code		
Definition	Specification of Contract Type expressed as a code		
Businessrules	A bilateral specified code if applicable.		
Dependency	../ContractType		

ContractType

Fieldname	ContractType	Alternative term	
Cardinality	0..1	Usage	Yes
Datatype	Text		
Definition	Specification of Contract Type expressed as text		
Businessrules	Use if no code is applicable.		
Dependency	../ContractTypeCode		

Class Specification

ValidityPeriod

Classname	ValidityPeriod	Alternative term	
Cardinality	0..1	Usage	Bilateral
Datatype	Period		
Definition	An association to ValidityPeriod		
See section	G30 3.78		

ContractDocumentReference

Classname	ContractDocumentReference	Alternative term	
Cardinality	0..1	Usage	Yes
Datatype	DocumentReference		
Definition	An association to ContractDocumentReference		
Recommendation	Can be used to attach the actual contract		
See section	3.3.1		

Excluded classes and fields in ReferencedContract (CatalogueItemSpecificationUpdate.ReferencedContract)

None

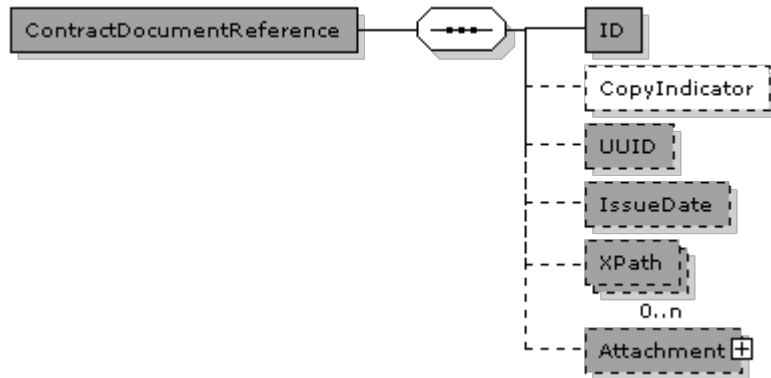

3.3.1.**CatalogueItemSpecificationUpdate.ReferencedContract.ContractDocumentReference****ContractDocumentReference****(CatalogueItemSpecificationUpdate.ReferencedContract.ContractDocumentReference) specification**

Name	CatalogueItemSpecificationUpdate.ReferencedContract.ContractDocumentReference	Alternative term	OIOUBL_GUIDE_DOCUMENTREF
Definition	Information about a Document referred to in another Document		
See also	OIOUBL_GUIDE_DOCUMENTREF (OIO)		

Fields

UBL-Name	Name	Datatype	Usage	Cardinality
ID	ID	Identifier	Yes	1
CopyIndicator	CopyIndicator	Indicator	Bilateral	0..1
UUID	UUID	Identifier	Yes	0..1
IssueDate	IssueDate	Date	Yes	0..1
XPath	XPath	Text	Yes	0..n

Subclasses in class ContractDocumentReference**(CatalogueItemSpecificationUpdate.ReferencedContract.ContractDocumentReference)**

UBL-Name	Name	Usage	Cardinality	Reference
Attachment	Attachment	Yes	0..1	3.3.1.1

Field specifications**ID**

Fieldname	ID	Alternative term	
Cardinality	1	Usage	Yes
Datatype	Identifier		
Definition	The identifier for the Document being referred to		
Example	428.34		

CopyIndicator

Fieldname	CopyIndicator	Alternative term	
Cardinality	0..1	Usage	Bilateral
Datatype	Indicator		
Definition	Indicates whether the referenced Document is a copy (true) or the original (false)		
Example	false		

UUID

Fieldname	UUID	Alternative term	OIOUBL_GUIDE_UUID
Cardinality	0..1	Usage	Yes
Datatype	Identifier		
Definition	A computer-generated universally unique identifier (UUID) for the referenced Document instance		
See also	OIOUBL_GUIDE_UUID (G32)		

IssueDate

Fieldname	IssueDate	Alternative term	
Cardinality	0..1	Usage	Yes
Datatype	Date		
Definition	The date assigned by the sender of the referenced Document on which the referenced Document was issued		
Example	2006-09-01		

XPath

Fieldname	XPath	Alternative term	
Cardinality	0..n	Usage	Yes
Datatype	Text		
Definition	Refers to another part of the same document instance		
Example	/DocumentReference[ID='428.22']		

Class Specification**Attachment**

Classname	Attachment	Alternative term	
Cardinality	0..1	Usage	Yes
Datatype	Attachment		
Definition	An attached document, external referred to, referred in the MIME location or embedded.		
See section	3.3.1.1		

**Excluded classes and fields in ContractDocumentReference
(CatalogueItemSpecificationUpdate.ReferencedContract.ContractDocumentReference)**

Name	Name	Type
DocumentTypeCode	DocumentTypeCode	Field
DocumentType	DocumentType	Field

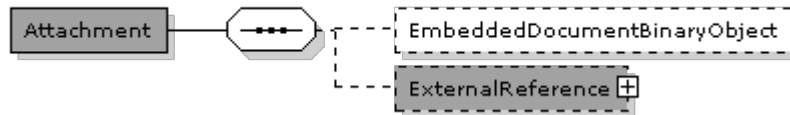
3.3.1.1.**CatalogueItemSpecificationUpdate.ReferencedContract.ContractDocumentReference.Attachment****Attachment****(CatalogueItemSpecificationUpdate.ReferencedContract.ContractDocumentReference.Attachment) specification**

Name	CatalogueItemSpecificationUpdate.ReferencedContract.ContractDocumentReference.Attachment	Alternative term	OIOUBL_GUIDE_ATTACHM ENT
Definition	Information about an attached document. An attachment can be referred to externally (with the URI element), internally (with the MIME reference element) or contained within the document itself (with the EmbeddedDocument element).		
See also	OIOUBL_GUIDE_ATTACHM ENT (OIO)		

Fields

UBL-Name	Name	Datatype	Usage	Cardinality
EmbeddedDocumentBinaryObject	EmbeddedDocumentBinaryObject	Binary Object	Bilateral	0..1

Subclasses in class Attachment**(CatalogueItemSpecificationUpdate.ReferencedContract.ContractDocumentReference.Attachment)**

UBL-Name	Name	Usage	Cardinality	Reference
ExternalReference	ExternalReference	Yes	0..1	G30 3.41

Field specifications***EmbeddedDocumentBinaryObject***

Fieldname	EmbeddedDocumentBinaryObject	Alternative term	
Cardinality	0..1	Usage	Bilateral
Datatype	Binary Object		
Definition	Contains an embedded document as a BLOB,		
Businessrules	Only allowed if no ExternalReference is specified and if bilateral agreed.		
Dependency	../ExternalReference		

Class Specification***ExternalReference***

Classname	ExternalReference	Alternative term	
Cardinality	0..1	Usage	Yes
Datatype	ExternalReference		
Definition	An attached document, external referred to, referred in the MIME location or embedded.		
Businessrules	Used if no EmbeddedDocumentBinaryObject specified		
Dependency	../EmbeddedDocumentBinaryObject		
See section	G30 3.41		

Excluded classes and fields in Attachment

(CatalogueItemSpecificationUpdate.ReferencedContract.ContractDocumentReference.Attachment)

None

3.4. CatalogueItemSpecificationUpdate.ProviderParty

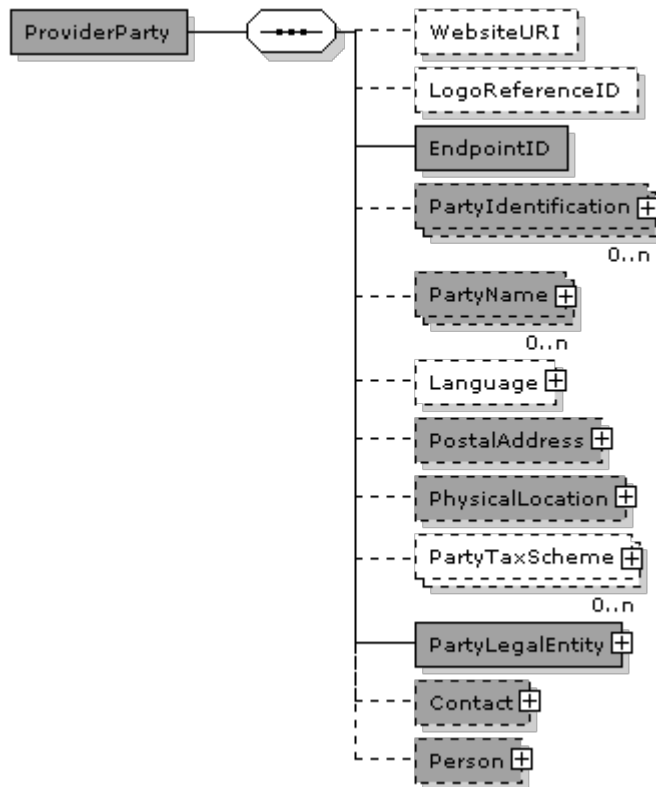

ProviderParty (CatalogueItemSpecificationUpdate.ProviderParty) specification

Name	CatalogueItemSpecificationUpdate.Provider Party	Alternative term	
Definition	Information about an organisation, sub-organisation or individual fulfilling a role in a business process		

Fields

UBL-Name	Name	Datatype	Usage	Cardinality
WebsiteURI	WebsiteURI	Identifier	Bilateral	0..1
LogoReferenceID	LogoReferenceID	Identifier	Bilateral	0..1
EndpointID	EndpointID	Identifier	Yes	1

Subclasses in class ProviderParty (CatalogueItemSpecificationUpdate.ProviderParty)

UBL-Name	Name	Usage	Cardinality	Reference
PartyIdentification	PartyIdentification	Yes	0..n	G30 3.71
PartyName	PartyName	Yes	0..n	G30 3.73
Language	Language	Bilateral	0..1	G30 3.56
PostalAddress	PostalAddress	Yes	0..1	G30 3.1
PhysicalLocation	PhysicalLocation	Yes	0..1	
PartyTaxScheme	PartyTaxScheme	Bilateral	0..n	G30 3.74
PartyLegalEntity	PartyLegalEntity	Yes	1	G30 3.72
Contact	Contact	Yes	0..1	G30 3.21
Person	Person	Yes	0..1	G30 3.79

Field specifications**WebsiteURI**

Fieldname	WebsiteURI	Alternative term	
Cardinality	0..1	Usage	Bilateral
Datatype	Identifier		
Definition	The Uniform Resource Identifier (URI) of the Party		

LogoReferenceID

Fieldname	LogoReferenceID	Alternative term	
Cardinality	0..1	Usage	Bilateral
Datatype	Identifier		
Definition	A Party's logo		

EndpointID

Fieldname	EndpointID	Alternative term	OIOUBL_GUIDE_ENDPOINT
Cardinality	1	Usage	Yes
Datatype	Identifier		
Definition	Identifies the end point of the routing service, e.g. EAN Location Number, GLN		
Id schemelist	urn:oioubl:scheme:endpointid-1.1		
See also	OIOUBL_GUIDE_ENDPOINT (OIO)		

Class Specification**PartyIdentification**

Classname	PartyIdentification	Alternative term	
Cardinality	0..n	Usage	Yes
Datatype	PartyIdentification		
Definition	An association to Party Identification		
Businessrules	PartyIdentification or PartyName must be specified.		
See section	G30 3.71		

PartyName

Classname	PartyName	Alternative term	
Cardinality	0..n	Usage	Yes
Datatype	PartyName		
Definition	An association to Party Name. Party Name must be used where no Party Identification is used.		
Businessrules	Mandatory if PartyIdentification/ID is not used.		
Recommendation	Only one Name per language		
Dependency	../PartyIdentification		
See section	G30 3.73		

Language

3.4. CatalogueItemSpecificationUpdate.ProviderParty

Classname	Language	Alternative term	
Cardinality	0..1	Usage	Bilateral
Datatype	Language		
Definition	An association to Language		
See section	G30 3.56		

PostalAddress

Classname	PostalAddress	Alternative term	
Cardinality	0..1	Usage	Yes
Datatype	Address		
Definition	The Party's postal address		
Businessrules	Use addresstype StructuredDK for addresses in Denmark		
Recommendation	At Header level Postaladdress should be supplied		
See section	G30 3.1		

PhysicalLocation

Classname	PhysicalLocation	Alternative term	
Cardinality	0..1	Usage	Yes
Datatype	Location		
Definition	The Party's visiting address		
Businessrules	Only specified if different from PostalAddress		
See section	G30 3.		

PartyTaxScheme

Classname	PartyTaxScheme	Alternative term	
Cardinality	0..n	Usage	Bilateral
Datatype	PartyTaxScheme		
Definition	An association to Party Tax Scheme		
See section	G30 3.74		

PartyLegalEntity

Classname	PartyLegalEntity	Alternative term	OIOUBL_GUIDE_PARTIES
Cardinality	1	Usage	Yes
Datatype	PartyLegalEntity		
Definition	An association to Party Legal Entity		
See section	G30 3.72		
See also	OIOUBL_GUIDE_PARTIES (OIO)		
Example	DK12345678 (schemeID = CVR)		

Contact

Classname	Contact	Alternative term	
Cardinality	0..1	Usage	Yes
Datatype	Contact		
Definition	An association to Contact		
Recommendation	The Contact information for the party		
See section	G30 3.21		

Person

Classname	Person	Alternative term	
Cardinality	0..1	Usage	Yes
Datatype	Person		
Definition	An association to a Person.		
Recommendation	Supplementary information for Contact		
See section	G30 3.79		

**Excluded classes and fields in ProviderParty
(CatalogueItemSpecificationUpdate.ProviderParty)**

Name	Name	Type
MarkCareIndicator	MarkCareIndicator	Field
MarkAttentionIndicator	MarkAttentionIndicator	Field
AgentParty	AgentParty	Class

3.5. CatalogueItemSpecificationUpdate.ReceiverParty

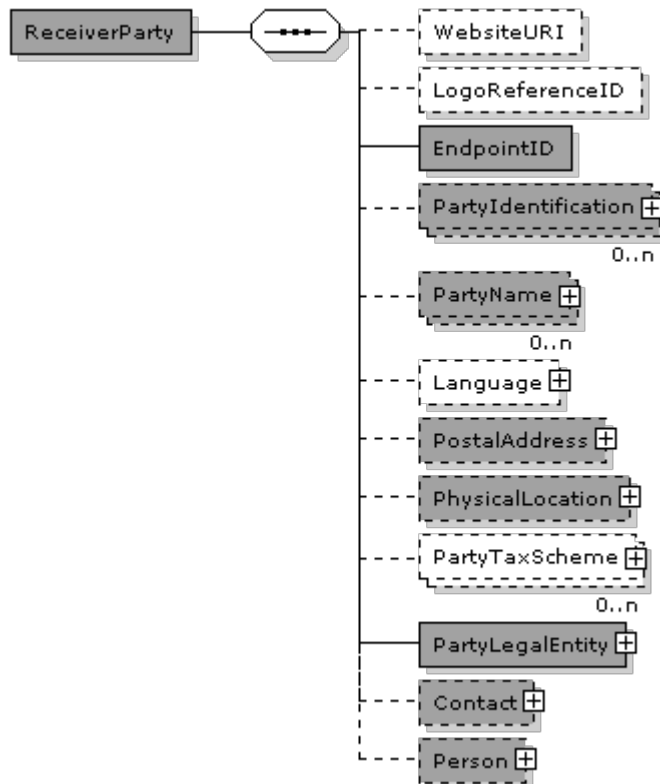

ReceiverParty (CatalogueItemSpecificationUpdate.ReceiverParty) specification

Name	CatalogueItemSpecificationUpdate.Receiver Party	Alternative term	
Definition	Information about an organisation, sub-organisation or individual fulfilling a role in a business process		

Fields

UBL-Name	Name	Datatype	Usage	Cardinality
WebsiteURI	WebsiteURI	Identifier	Bilateral	0..1
LogoReferenceID	LogoReferenceID	Identifier	Bilateral	0..1
EndpointID	EndpointID	Identifier	Yes	1

Subclasses in class ReceiverParty (CatalogueItemSpecificationUpdate.ReceiverParty)

UBL-Name	Name	Usage	Cardinality	Reference
PartyIdentification	PartyIdentification	Yes	0..n	G30 3.71
PartyName	PartyName	Yes	0..n	G30 3.73
Language	Language	Bilateral	0..1	G30 3.56
PostalAddress	PostalAddress	Yes	0..1	G30 3.1
PhysicalLocation	PhysicalLocation	Yes	0..1	
PartyTaxScheme	PartyTaxScheme	Bilateral	0..n	G30 3.74
PartyLegalEntity	PartyLegalEntity	Yes	1	G30 3.72
Contact	Contact	Yes	0..1	G30 3.21
Person	Person	Yes	0..1	G30 3.79

Field specifications**WebsiteURI**

Fieldname	WebsiteURI	Alternative term	
Cardinality	0..1	Usage	Bilateral
Datatype	Identifier		
Definition	The Uniform Resource Identifier (URI) of the Party		

LogoReferenceID

Fieldname	LogoReferenceID	Alternative term	
Cardinality	0..1	Usage	Bilateral
Datatype	Identifier		
Definition	A Party's logo		

EndpointID

Fieldname	EndpointID	Alternative term	OIOUBL_GUIDE_ENDPOINT
Cardinality	1	Usage	Yes
Datatype	Identifier		
Definition	Identifies the end point of the routing service, e.g. EAN Location Number, GLN		
Id schemelist	urn:oioubl:scheme:endpointid-1.1		
See also	OIOUBL_GUIDE_ENDPOINT (OIO)		

Class Specification**PartyIdentification**

Classname	PartyIdentification	Alternative term	
Cardinality	0..n	Usage	Yes
Datatype	PartyIdentification		
Definition	An association to Party Identification		
Businessrules	PartyIdentification or PartyName must be specified.		
See section	G30 3.71		

PartyName

Classname	PartyName	Alternative term	
Cardinality	0..n	Usage	Yes
Datatype	PartyName		
Definition	An association to Party Name. Party Name must be used where no Party Identification is used.		
Businessrules	Mandatory if PartyIdentification/ID is not used.		
Recommendation	Only one Name per language		
Dependency	../PartyIdentification		
See section	G30 3.73		

Language

3.5. CatalogueItemSpecificationUpdate.ReceiverParty

Classname	Language	Alternative term	
Cardinality	0..1	Usage	Bilateral
Datatype	Language		
Definition	An association to Language		
See section	G30 3.56		

PostalAddress

Classname	PostalAddress	Alternative term	
Cardinality	0..1	Usage	Yes
Datatype	Address		
Definition	The Party's postal address		
Businessrules	Use addresstype StructuredDK for addresses in Denmark		
Recommendation	At Header level Postaladdress should be supplied		
See section	G30 3.1		

PhysicalLocation

Classname	PhysicalLocation	Alternative term	
Cardinality	0..1	Usage	Yes
Datatype	Location		
Definition	The Party's visiting address		
Businessrules	Only specified if different from PostalAddress		
See section	G30 3.		

PartyTaxScheme

Classname	PartyTaxScheme	Alternative term	
Cardinality	0..n	Usage	Bilateral
Datatype	PartyTaxScheme		
Definition	An association to Party Tax Scheme		
See section	G30 3.74		

PartyLegalEntity

Classname	PartyLegalEntity	Alternative term	OIOUBL_GUIDE_PARTIES
Cardinality	1	Usage	Yes
Datatype	PartyLegalEntity		
Definition	An association to Party Legal Entity		
See section	G30 3.72		
See also	OIOUBL_GUIDE_PARTIES (OIO)		
Example	DK12345678 (schemeID = CVR)		

Contact

Classname	Contact	Alternative term	
Cardinality	0..1	Usage	Yes
Datatype	Contact		
Definition	An association to Contact		
Recommendation	The Contact information for the party		
See section	G30 3.21		

Person

Classname	Person	Alternative term	
Cardinality	0..1	Usage	Yes
Datatype	Person		
Definition	An association to a Person.		
Recommendation	Supplementary information for Contact		
See section	G30 3.79		

**Excluded classes and fields in ReceiverParty
(CatalogueItemSpecificationUpdate.ReceiverParty)**

Name	Name	Type
MarkCareIndicator	MarkCareIndicator	Field
MarkAttentionIndicator	MarkAttentionIndicator	Field
AgentParty	AgentParty	Class

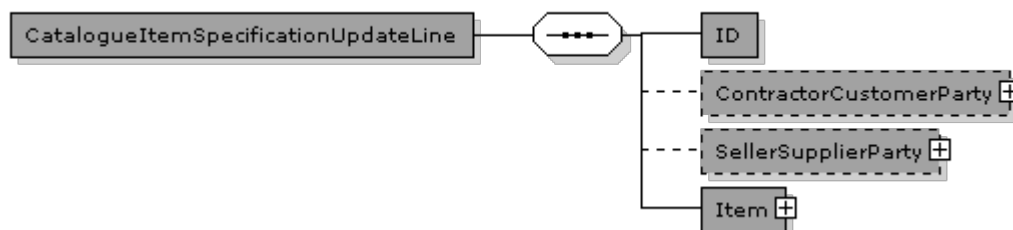
3.6.**CatalogueItemSpecificationUpdate.CatalogueItemSpecificationUpdateLine****CatalogueItemSpecificationUpdateLine****(CatalogueItemSpecificationUpdate.CatalogueItemSpecificationUpdateLine) specification**

Name	CatalogueItemSpecificationUpdate.CatalogueItemSpecificationUpdateLine	Alternative term	
Definition	Information about CatalogueLineItemSpecification		

Fields

UBL-Name	Name	Datatype	Usage	Cardinality
ID	ID	Identifier	Yes	1

Subclasses in class CatalogueItemSpecificationUpdateLine**(CatalogueItemSpecificationUpdate.CatalogueItemSpecificationUpdateLine)**

UBL-Name	Name	Usage	Cardinality	Reference
ContractorCustomerParty	ContractorCustomerParty	Yes	0..1	G30 3.27
SellerSupplierParty	SellerSupplierParty	Yes	0..1	G30 3.100
Item	Item	Yes	1	3.6.1

Field specifications**ID**

Fieldname	ID	Alternative term	
Cardinality	1	Usage	Yes
Datatype	Identifier		
Definition	A unique instanceID for the line in this cataloguedocument.		

Class Specification

3.6. CatalogueItemSpecificationUpdate.CatalogueItemSpecificationUpdateLine

ContractorCustomerParty

Classname	ContractorCustomerParty	Alternative term	OIOUBL_GUIDE_CATALOGUE_PARTIES
Cardinality	0..1	Usage	Yes
Datatype	CustomerParty		
Definition	The CustomerParty responsible for the contract referred to in the catalogue		
Businessrules	If the ContractorCustomerParty is specified on the CatalogueLine the line is only valid for that customer. This makes it possible to specify products for different customers in the same catalogue document e.g. for a marketplace.		
See section	G30 3.27		
See also	OIOUBL_GUIDE_CATALOGUE_PARTIES (OIO)		

SellerSupplierParty

Classname	SellerSupplierParty	Alternative term	OIOUBL_GUIDE_CATALOGUE_PARTIES
Cardinality	0..1	Usage	Yes
Datatype	SupplierParty		
Definition	An association to the Seller of the item.		
Businessrules	The SellerSupplierParty on the CatalogueLine makes it possible to hold products from different suppliers in the same Catalogue document. Note that a SellerSupplierParty on the line overrules the SellerSupplierParty on the header		
See section	G30 3.100		
See also	OIOUBL_GUIDE_CATALOGUE_PARTIES (OIO)		

Item

Classname	Item	Alternative term	OIOUBL_GUIDE_CATALOGUE_ITEMDESCR
Cardinality	1	Usage	Yes
Datatype	Item		
Definition	An association to the item in question		
Businessrules	Note that the whole existing Item is overwritten when updating the CatalogueLine.		
See section	3.6.1		
See also	OIOUBL_GUIDE_CATALOGUE_ITEMDESCR (OIO)		

Excluded classes and fields in CatalogueItemSpecificationUpdateLine (CatalogueItemSpecificationUpdate.CatalogueItemSpecificationUpdateLine)

None

3.6.1.

CatalogueItemSpecificationUpdate.CatalogueItemSpecificationUpdateLine.Item

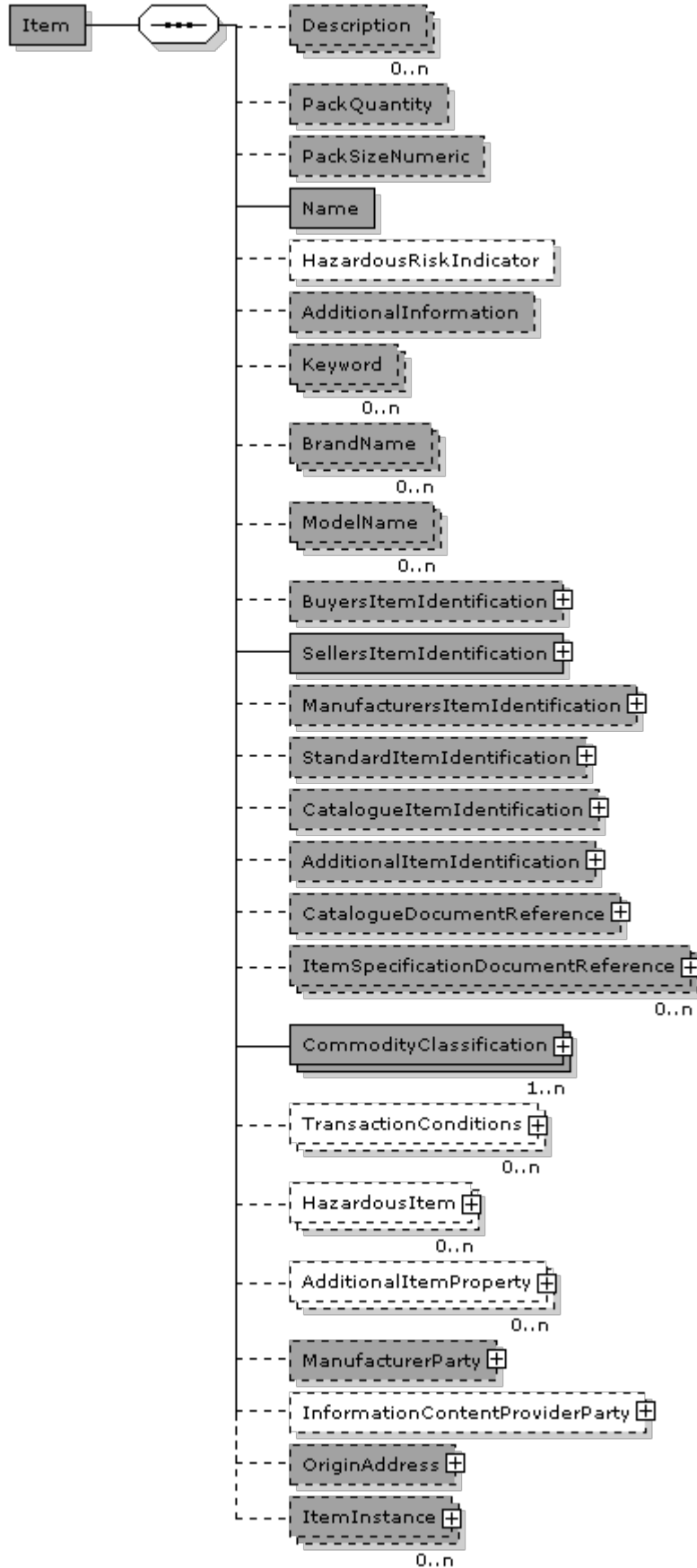

Item (CatalogueItemSpecificationUpdate.CatalogueItemSpecificationUpdateLine.Item) specification

Name	CatalogueItemSpecificationUpdate.CatalogueItemSpecificationUpdateLine.Item	Alternative term	
Definition	Information directly relating to an item		

Fields

UBL-Name	Name	Datatype	Usage	Cardinality
Description	Description	Text	Yes	0..n
PackQuantity	PackQuantity	Quantity	Yes	0..1
PackSizeNumeric	PackSizeNumeric	Numeric	Yes	0..1
Name	Name	Name	Yes	1
HazardousRiskIndicator	HazardousRiskIndicator	Indicator	Bilateral	0..1
AdditionalInformation	AdditionalInformation	Text	Yes	0..1
Keyword	Keyword	Text	Yes	0..n
BrandName	BrandName	Name	Yes	0..n
ModelName	ModelName	Name	Yes	0..n

Subclasses in class Item (CatalogueItemSpecificationUpdate.CatalogueItemSpecificationUpdateLine.Item)

UBL-Name	Name	Usage	Cardinality	Reference
BuyersItemIdentification	BuyersItemIdentification	Yes	0..1	3.6.1.1
SellersItemIdentification	SellersItemIdentification	Yes	1	3.6.1.2
ManufacturersItemIdentification	ManufacturersItemIdentification	Yes	0..1	3.6.1.3
StandardItemIdentification	StandardItemIdentification	Yes	0..1	3.6.1.4
CatalogueItemIdentification	CatalogueItemIdentification	Yes	0..1	3.6.1.5
AdditionalItemIdentification	AdditionalItemIdentification	Yes	0..1	3.6.1.6
CatalogueDocumentReference	CatalogueDocumentReference	Yes	0..1	3.6.1.7
ItemSpecificationDocumentReference	ItemSpecificationDocumentReference	Yes	0..n	3.6.1.8
CommodityClassification	CommodityClassification	Yes	1..n	3.6.1.9
TransactionConditions	TransactionConditions	Bilateral	0..n	G30 3.107
HazardousItem	HazardousItem	Bilateral	0..n	G30 3.47
AdditionalItemProperty	AdditionalItemProperty	Bilateral	0..n	3.6.1.10
ManufacturerParty	ManufacturerParty	Yes	0..1	G30 3.70
InformationContentProviderParty	InformationContentProviderParty	Bilateral	0..1	G30 3.70
OriginAddress	OriginAddress	Yes	0..1	G30 3.1
ItemInstance	ItemInstance	Yes	0..n	G30 3.52

Field specifications**Description**

Fieldname	Description	Alternative term	
Cardinality	0..n	Usage	Yes
Datatype	Text		
Definition	A free form text field that can be used to give a text description of the item.		
Recommendation	Only one per Language		

PackQuantity

Fieldname	PackQuantity	Alternative term	
Cardinality	0..1	Usage	Yes
Datatype	Quantity		
Definition	The unit packaging quantity.		
Example	1 (unitCode ='CS')		

PackSizeNumeric

Fieldname	PackSizeNumeric	Alternative term	
Cardinality	0..1	Usage	Yes
Datatype	Numeric		
Definition	The number of items in a package.		
Example	12		

Name

Fieldname	Name	Alternative term	
Cardinality	1	Usage	Yes
Datatype	Name		
Definition	A shortname (optionally) given to an item, such as a name from a catalogue, as distinct to a description		
Recommendation	Should not exceed 40 characters		
Example	"Colgate Total", "Batteries AA 12V"		

HazardousRiskIndicator

Fieldname	HazardousRiskIndicator	Alternative term	
Cardinality	0..1	Usage	Bilateral
Datatype	Indicator		
Definition	An indicator as to whether the item as delivered is hazardous		
Legal values	true, false		

AdditionalInformation

Fieldname	AdditionalInformation	Alternative term	
Cardinality	0..1	Usage	Yes
Datatype	Text		
Definition	To provide more details of the item (eg URL of a relevant web page).		

Keyword

Fieldname	Keyword	Alternative term	
Cardinality	0..n	Usage	Yes
Datatype	Text		
Definition	A Seller Party-defined search string for the item. Could also be synonyms.		
Recommendation	Should be used in catalogues to optimize the search for items by specifying known synonyms for the item. If Name is "Colgate Total" and the customer search for "toothpaste" the customer will not find the item.		
Example	Toothpaste		

BrandName

Fieldname	BrandName	Alternative term	
Cardinality	0..n	Usage	Yes
Datatype	Name		
Definition	The brand name for the item.		

ModelName

Fieldname	ModelName	Alternative term	
Cardinality	0..n	Usage	Yes
Datatype	Name		
Definition	Model name for the item		

Class Specification**BuyersItemIdentification**

Classname	BuyersItemIdentification	Alternative term	OIOUBL_GUIDE_CATALOGUE_ITEMDESCR
Cardinality	0..1	Usage	Yes
Datatype	ItemIdentification		
Definition	Associates the item with its identification according to the buyers system.		
See section	3.6.1.1		
See also	OIOUBL_GUIDE_CATALOGUE_ITEMDESCR (OIO)		

SellersItemIdentification

Classname	SellersItemIdentification	Alternative term	OIOUBL_GUIDE_CATALOGUE_ITEMDESCR
Cardinality	1	Usage	Yes
Datatype	ItemIdentification		
Definition	Associates the item with its identification according to the sellers system.		
See section	3.6.1.2		
See also	OIOUBL_GUIDE_CATALOGUE_ITEMDESCR (OIO)		

ManufacturersItemIdentification

Classname	ManufacturersItemIdentification	Alternative term	OIOUBL_GUIDE_CATALOGUE_ITEMDESCR
Cardinality	0..1	Usage	Yes
Datatype	ItemIdentification		
Definition	Associates the item with its identification according to the manufacturers system.		
See section	3.6.1.3		
See also	OIOUBL_GUIDE_CATALOGUE_ITEMDESCR (OIO)		

StandardItemIdentification

Classname	StandardItemIdentification	Alternative term	OIOUBL_GUIDE_CATALOGUE_ITEMDESCR
Cardinality	0..1	Usage	Yes
Datatype	ItemIdentification		
Definition	Associates the item with its identification according to a standard system.		
See section	3.6.1.4		
See also	OIOUBL_GUIDE_CATALOGUE_ITEMDESCR (OIO)		

CatalogueItemIdentification

Classname	CatalogueItemIdentification	Alternative term	OIOUBL_GUIDE_CATALOGUE_ITEMDESCR
Cardinality	0..1	Usage	Yes
Datatype	ItemIdentification		
Definition	Associates the item with its identification according to a cataloguing system.		
See section	3.6.1.5		
See also	OIOUBL_GUIDE_CATALOGUE_ITEMDESCR (OIO)		

AdditionalItemIdentification

Classname	AdditionalItemIdentification	Alternative term	OIOUBL_GUIDE_CATALOGUE_ITEMDESCR
Cardinality	0..1	Usage	Yes
Datatype	ItemIdentification		
Definition	Associates the item with other identification means		
See section	3.6.1.6		
See also	OIOUBL_GUIDE_CATALOGUE_ITEMDESCR (OIO)		

3.6.1. CatalogueItemSpecificationUpdate.CatalogueItemSpecificationUpdateLine.Item

CatalogueDocumentReference

Classname	CatalogueDocumentReference	Alternative term	
Cardinality	0..1	Usage	Yes
Datatype	DocumentReference		
Definition	Associates the item with the catalogue from which the item was selected.		
See section	3.6.1.7		

ItemSpecificationDocumentReference

Classname	ItemSpecificationDocumentReference	Alternative term	
Cardinality	0..n	Usage	Yes
Datatype	DocumentReference		
Definition	An association to item specification		
See section	3.6.1.8		

CommodityClassification

Classname	CommodityClassification	Alternative term	
Cardinality	1..n	Usage	Yes
Datatype	CommodityClassification		
Definition	Associates the item with its classification(s) according to a commodity classifying system.		
See section	3.6.1.9		

TransactionConditions

Classname	TransactionConditions	Alternative term	
Cardinality	0..n	Usage	Bilateral
Datatype	TransactionConditions		
Definition	Associates the item with sales conditions appertaining to it.		
See section	G30 3.107		

HazardousItem

Classname	HazardousItem	Alternative term	
Cardinality	0..n	Usage	Bilateral
Datatype	HazardousItem		
Definition	Associates the item with its hazardous item information.		
See section	G30 3.47		

AdditionalItemProperty

Classname	AdditionalItemProperty	Alternative term	
Cardinality	0..n	Usage	Bilateral
Datatype	ItemProperty		
Definition	Associates the item with a set of additional properties		
See section	3.6.1.10		

ManufacturerParty

Classname	ManufacturerParty	Alternative term	
Cardinality	0..1	Usage	Yes
Datatype	Party		
Definition	An association to the manufacturer of the item.		
See section	G30 3.70		

InformationContentProviderParty

Classname	InformationContentProviderParty	Alternative term	
Cardinality	0..1	Usage	Bilateral
Datatype	Party		
Definition	Associates the item with the party responsible for the technical specifications of the item.		
See section	G30 3.70		

OriginAddress

3.6.1. CatalogueItemSpecificationUpdate.CatalogueItemSpecificationUpdateLine.Item

Classname	OriginAddress	Alternative term	
Cardinality	0..1	Usage	Yes
Datatype	Address		
Definition	Associates the item with the region of origin (i.e. not the country)		
See section	G30 3.1		

ItemInstance

Classname	ItemInstance	Alternative term	
Cardinality	0..n	Usage	Yes
Datatype	ItemInstance		
Definition	An association to Item Instance		
See section	G30 3.52		

Excluded classes and fields in Item (CatalogueItemSpecificationUpdate.CatalogueItemSpecificationUpdateLine.Item)

Name	Name	Type
CatalogueIndicator	CatalogueIndicator	Field
OriginCountry	OriginCountry	Class
ClassifiedTaxCategory	ClassifiedTaxCategory	Class

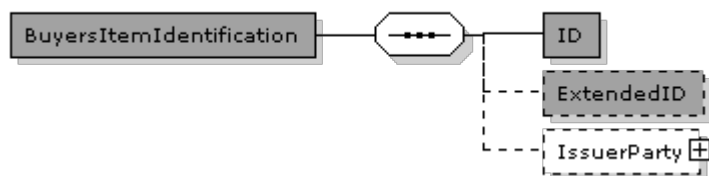
3.6.1.1.**CatalogueItemSpecificationUpdate.CatalogueItemSpecificationUpdateLine.Item.BuyersItemIdentification****BuyersItemIdentification****(CatalogueItemSpecificationUpdate.CatalogueItemSpecificationUpdateLine.Item.BuyersItemIdentification) specification**

Name	CatalogueItemSpecificationUpdate.CatalogueItemSpecificationUpdateLine.Item.BuyersItemIdentification	Alternative term	
Definition	Information about Item identification		

Fields

UBL-Name	Name	Datatype	Usage	Cardinality
ID	ID	Identifier	Yes	1
ExtendedID	ExtendedID	Identifier	Yes	0..1

Subclasses in class BuyersItemIdentification**(CatalogueItemSpecificationUpdate.CatalogueItemSpecificationUpdateLine.Item.BuyersItemIdentification)**

UBL-Name	Name	Usage	Cardinality	Reference
IssuerParty	IssuerParty	Bilateral	0..1	G30 3.70

Field specifications**ID**

Fieldname	ID	Alternative term	
Cardinality	1	Usage	Yes
Datatype	Identifier		
Definition	An identifier for an Item		

ExtendedID

Fieldname	ExtendedID	Alternative term	
Cardinality	0..1	Usage	Yes
Datatype	Identifier		
Definition	An extended identifier for the item which identifies the item with specific properties e.g. Item 123 = Chair / Item 123 Ext 45 = Brown chair		

Class Specification**IssuerParty**

Classname	IssuerParty	Alternative term	
Cardinality	0..1	Usage	Bilateral
Datatype	Party		
Definition	An association to Issuer Party i.e. the Party that issued the Item Identification		
See section	G30 3.70		

Excluded classes and fields in BuyersItemIdentification

(CatalogueItemSpecificationUpdate.CatalogueItemSpecificationUpdateLine.Item.BuyersItemIdentification)

Name	Name	Type
PhysicalAttribute	PhysicalAttribute	Class
MeasurementDimension	MeasurementDimension	Class

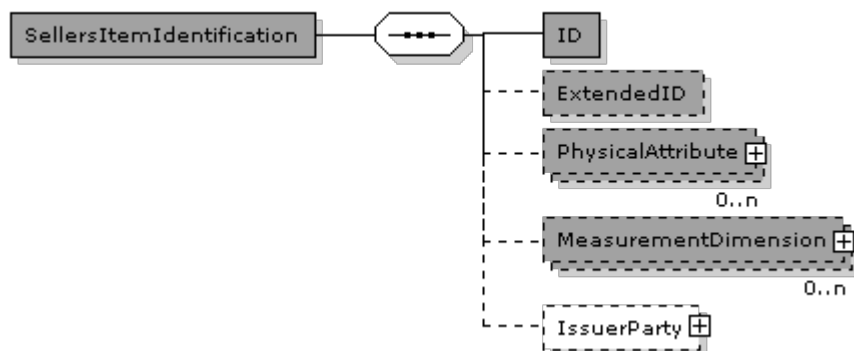
3.6.1.2.**CatalogueItemSpecificationUpdate.CatalogueItemSpecificationUpdateLine.Item.SellersItemIdentification****SellersItemIdentification****(CatalogueItemSpecificationUpdate.CatalogueItemSpecificationUpdateLine.Item.SellersItemIdentification) specification**

Name	CatalogueItemSpecificationUpdate.CatalogueItemSpecificationUpdateLine.Item.SellersItemIdentification	Alternative term	
Definition	Information about Item identification		

Fields

UBL-Name	Name	Datatype	Usage	Cardinality
ID	ID	Identifier	Yes	1
ExtendedID	ExtendedID	Identifier	Yes	0..1

Subclasses in class SellersItemIdentification**(CatalogueItemSpecificationUpdate.CatalogueItemSpecificationUpdateLine.Item.SellersItemIdentification)**

UBL-Name	Name	Usage	Cardinality	Reference
PhysicalAttribute	PhysicalAttribute	Yes	0..n	3.6.1.2.1
MeasurementDimension	MeasurementDimension	Yes	0..n	3.6.1.2.2
IssuerParty	IssuerParty	Bilateral	0..1	G30 3.70

Field specifications**ID**

Fieldname	ID	Alternative term	
Cardinality	1	Usage	Yes
Datatype	Identifier		
Definition	An identifier for an Item		

ExtendedID

Fieldname	ExtendedID	Alternative term	
Cardinality	0..1	Usage	Yes
Datatype	Identifier		
Definition	An extended identifier for the item which identifies the item with specific properties e.g. Item 123 = Chair / Item 123 Ext 45 = Brown chair		

Class Specification**PhysicalAttribute**

Classname	PhysicalAttribute	Alternative term	
Cardinality	0..n	Usage	Yes
Datatype	PhysicalAttribute		
Definition	An association to Physical Attributes		
See section	3.6.1.2.1		

MeasurementDimension

Classname	MeasurementDimension	Alternative term	
Cardinality	0..n	Usage	Yes
Datatype	Dimension		
Definition	An association to Measurement Dimension		
See section	3.6.1.2.2		

IssuerParty

Classname	IssuerParty	Alternative term	
Cardinality	0..1	Usage	Bilateral
Datatype	Party		
Definition	An association to Issuer Party i.e. the Party that issued the Item Identification		
See section	G30 3.70		

Excluded classes and fields in SellersItemIdentification

(CatalogueItemSpecificationUpdate.CatalogueItemSpecificationUpdateLine.Item.SellersItemIdentification)

None

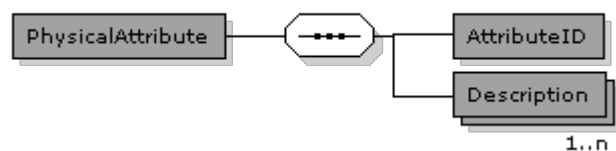
3.6.1.2.1.**CatalogueItemSpecificationUpdate.CatalogueItemSpecificationUpdateLine.Item.SellersItemIdentification.PhysicalAttribute****PhysicalAttribute****(CatalogueItemSpecificationUpdate.CatalogueItemSpecificationUpdateLine.Item.SellersItemIdentification.PhysicalAttribute) specification**

Name	CatalogueItemSpecificationUpdate.CatalogueItemSpecificationUpdateLine.Item.SellersItemIdentification.PhysicalAttribute	Alternative term	
Definition	Information about Physical Attributes		

Fields

UBL-Name	Name	Datatype	Usage	Cardinality
AttributeID	AttributeID	Identifier	Yes	1
Description	Description	Text	Yes	1..n

Subclasses in class PhysicalAttribute**(CatalogueItemSpecificationUpdate.CatalogueItemSpecificationUpdateLine.Item.SellersItemIdentification.PhysicalAttribute)**

None

CatalogueItemSpecificationUpdate.CatalogueItemSpecificationUpdateLine.Item.SellersItemIdentification.PhysicalAttribute

Field specifications

AttributeID

Fieldname	AttributeID	Alternative term	
Cardinality	1	Usage	Yes
Datatype	Identifier		
Definition	Identification for PhysicalAttribute		

Description

Fieldname	Description	Alternative term	
Cardinality	1..n	Usage	Yes
Datatype	Text		
Definition	The description of PhysicalAttribute specified as text		

Excluded classes and fields in PhysicalAttribute (CatalogueItemSpecificationUpdate.CatalogueItemSpecificationUpdateLine.Item.SellersItemIdentification.PhysicalAttribute)

Name	Name	Type
PositionCode	PositionCode	Field
DescriptionCode	DescriptionCode	Field

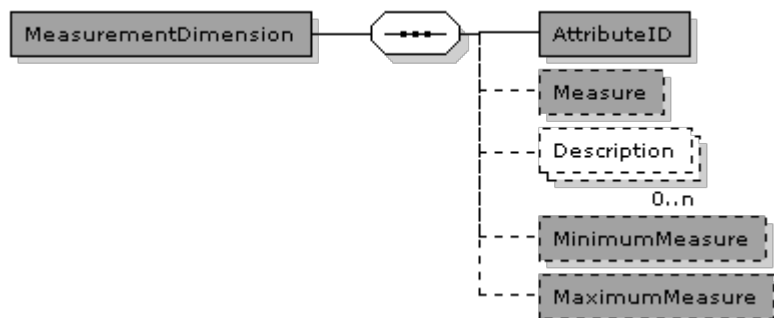
3.6.1.2.2.**CatalogueItemSpecificationUpdate.CatalogueItemSpecificationUpdateLine.Item.SellersItemIdentification.MeasurementDimension****MeasurementDimension****(CatalogueItemSpecificationUpdate.CatalogueItemSpecificationUpdateLine.Item.SellersItemIdentification.MeasurementDimension) specification**

Name	CatalogueItemSpecificationUpdate.CatalogueItemSpecificationUpdateLine.Item.SellersItemIdentification.MeasurementDimension	Alternative term	
Definition	Information about a measurable dimension for an Item		

Fields

UBL-Name	Name	Datatype	Usage	Cardinality
AttributeID	AttributeID	Identifier	Yes	1
Measure	Measure	Measure	Yes	0..1
Description	Description	Text	Bilateral	0..n
MinimumMeasure	MinimumMeasure	Measure	Yes	0..1
MaximumMeasure	MaximumMeasure	Measure	Yes	0..1

Subclasses in class MeasurementDimension**(CatalogueItemSpecificationUpdate.CatalogueItemSpecificationUpdateLine.Item.SellersItemIdentification.MeasurementDimension)**

None

CatalogueItemSpecificationUpdate.CatalogueItemSpecificationUpdateLine.Item.SellersItemIdentification.MeasurementDimension

Field specifications

AttributeID

Fieldname	AttributeID	Alternative term	
Cardinality	1	Usage	Yes
Datatype	Identifier		
Definition	Identification for the Attribute the measurement applies to		
Example	Weight		

Measure

Fieldname	Measure	Alternative term	
Cardinality	0..1	Usage	Yes
Datatype	Measure		
Definition	The value of the measurement		
Recommendation	Measure should be specified if MinimumMeasure and MinimumMeasure is not used		
Example	20 (unitCode ='GRM')		

Description

Fieldname	Description	Alternative term	
Cardinality	0..n	Usage	Bilateral
Datatype	Text		
Definition	A description of the Attribute or the measurement of the Attribute		
Recommendation	Only one per Language		

MinimumMeasure

Fieldname	MinimumMeasure	Alternative term	
Cardinality	0..1	Usage	Yes
Datatype	Measure		
Definition	The minimum value in a measurement interval.		

MaximumMeasure

Fieldname	MaximumMeasure	Alternative term	
Cardinality	0..1	Usage	Yes
Datatype	Measure		
Definition	The maximum value in a measurement interval.		

Excluded classes and fields in MeasurementDimension

(CatalogueItemSpecificationUpdate.CatalogueItemSpecificationUpdateLine.Item.SellersItemIdentification.MeasurementDimension)

None

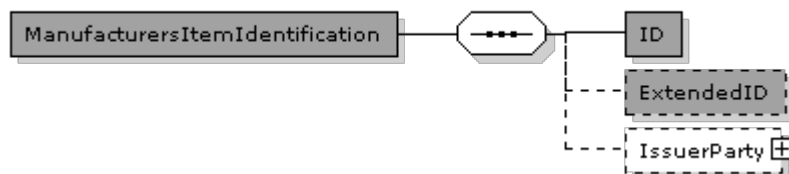
3.6.1.3.***CatalogueItemSpecificationUpdate.CatalogueItemSpecificationUpdateLine.Item.ManufacturersItemIdentification*****ManufacturersItemIdentification****(CatalogueItemSpecificationUpdate.CatalogueItemSpecificationUpdateLine.Item.ManufacturersItemIdentification) specification**

Name	CatalogueItemSpecificationUpdate.CatalogueItemSpecificationUpdateLine.Item.ManufacturersItemIdentification	Alternative term	
Definition	Information about Item identification		

Fields

UBL-Name	Name	Datatype	Usage	Cardinality
ID	ID	Identifier	Yes	1
ExtendedID	ExtendedID	Identifier	Yes	0..1

Subclasses in class ManufacturersItemIdentification**(CatalogueItemSpecificationUpdate.CatalogueItemSpecificationUpdateLine.Item.ManufacturersItemIdentification)**

UBL-Name	Name	Usage	Cardinality	Reference
IssuerParty	IssuerParty	Bilateral	0..1	G30 3.70

CatalogueItemSpecificationUpdate.CatalogueItemSpecificationUpdateLine.Item.ManufacturersItemIdentification

Field specifications

ID

Fieldname	ID	Alternative term	
Cardinality	1	Usage	Yes
Datatype	Identifier		
Definition	An identifier for an Item		

ExtendedID

Fieldname	ExtendedID	Alternative term	
Cardinality	0..1	Usage	Yes
Datatype	Identifier		
Definition	An extended identifier for the item which identifies the item with specific properties e.g. Item 123 = Chair / Item 123 Ext 45 = Brown chair		

Class Specification

IssuerParty

Classname	IssuerParty	Alternative term	
Cardinality	0..1	Usage	Bilateral
Datatype	Party		
Definition	An association to Issuer Party i.e. the Party that issued the Item Identification		
See section	G30 3.70		

Excluded classes and fields in ManufacturersItemIdentification

(CatalogueItemSpecificationUpdate.CatalogueItemSpecificationUpdateLine.Item.ManufacturersItemIdentification)

Name	Name	Type
PhysicalAttribute	PhysicalAttribute	Class
MeasurementDimension	MeasurementDimension	Class

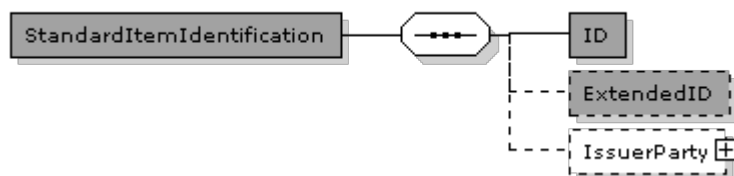
3.6.1.4.**CatalogueItemSpecificationUpdate.CatalogueItemSpecificationUpdateLine.Item.StandardItemIdentification****StandardItemIdentification****(CatalogueItemSpecificationUpdate.CatalogueItemSpecificationUpdateLine.Item.StandardItemIdentification) specification**

Name	CatalogueItemSpecificationUpdate.CatalogueItemSpecificationUpdateLine.Item.StandardItemIdentification	Alternative term	
Definition	Information about Item identification		

Fields

UBL-Name	Name	Datatype	Usage	Cardinality
ID	ID	Identifier	Yes	1
ExtendedID	ExtendedID	Identifier	Yes	0..1

Subclasses in class StandardItemIdentification**(CatalogueItemSpecificationUpdate.CatalogueItemSpecificationUpdateLine.Item.StandardItemIdentification)**

UBL-Name	Name	Usage	Cardinality	Reference
IssuerParty	IssuerParty	Bilateral	0..1	G30 3.70

Field specifications**ID**

Fieldname	ID	Alternative term	
Cardinality	1	Usage	Yes
Datatype	Identifier		
Definition	An identifier for an Item		

ExtendedID

Fieldname	ExtendedID	Alternative term	
Cardinality	0..1	Usage	Yes
Datatype	Identifier		
Definition	An extended identifier for the item which identifies the item with specific properties e.g. Item 123 = Chair / Item 123 Ext 45 = Brown chair		

Class Specification**IssuerParty**

Classname	IssuerParty	Alternative term	
Cardinality	0..1	Usage	Bilateral
Datatype	Party		
Definition	An association to Issuer Party i.e. the Party that issued the Item Identification		
See section	G30 3.70		

**Excluded classes and fields in StandardItemIdentification
(CatalogueItemSpecificationUpdate.CatalogueItemSpecificationUpdateLine.Item.StandardItemIdentification)**

Name	Name	Type
PhysicalAttribute	PhysicalAttribute	Class
MeasurementDimension	MeasurementDimension	Class

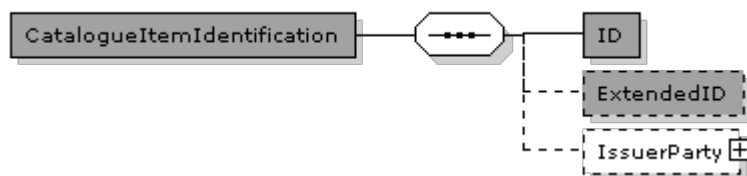
3.6.1.5.**CatalogueItemSpecificationUpdate.CatalogueItemSpecificationUpdateLine.Item.CatalogueItemIdentification****CatalogueItemIdentification****(CatalogueItemSpecificationUpdate.CatalogueItemSpecificationUpdateLine.Item.CatalogueItemIdentification) specification**

Name	CatalogueItemSpecificationUpdate.CatalogueItemSpecificationUpdateLine.Item.CatalogueItemIdentification	Alternative term	
Definition	Information about Item identification		

Fields

UBL-Name	Name	Datatype	Usage	Cardinality
ID	ID	Identifier	Yes	1
ExtendedID	ExtendedID	Identifier	Yes	0..1

Subclasses in class CatalogueItemIdentification**(CatalogueItemSpecificationUpdate.CatalogueItemSpecificationUpdateLine.Item.CatalogueItemIdentification)**

UBL-Name	Name	Usage	Cardinality	Reference
IssuerParty	IssuerParty	Bilateral	0..1	G30 3.70

Field specifications**ID**

Fieldname	ID	Alternative term	
Cardinality	1	Usage	Yes
Datatype	Identifier		
Definition	An identifier for an Item		

ExtendedID

Fieldname	ExtendedID	Alternative term	
Cardinality	0..1	Usage	Yes
Datatype	Identifier		
Definition	An extended identifier for the item which identifies the item with specific properties e.g. Item 123 = Chair / Item 123 Ext 45 = Brown chair		

Class Specification**IssuerParty**

Classname	IssuerParty	Alternative term	
Cardinality	0..1	Usage	Bilateral
Datatype	Party		
Definition	An association to Issuer Party i.e. the Party that issued the Item Identification		
See section	G30 3.70		

**Excluded classes and fields in CatalogueItemIdentification
(CatalogueItemSpecificationUpdate.CatalogueItemSpecificationUpdateLine.Item.CatalogueItemIdentification)**

Name	Name	Type
PhysicalAttribute	PhysicalAttribute	Class
MeasurementDimension	MeasurementDimension	Class

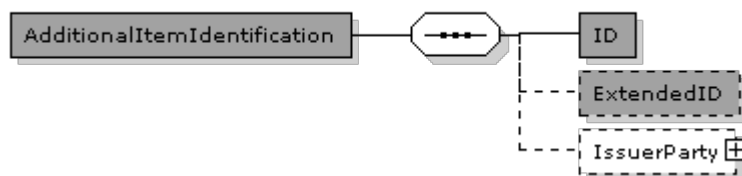
3.6.1.6.***CatalogueItemSpecificationUpdate.CatalogueItemSpecificationUpdateLine.Item.AdditionalItemIdentification*****AdditionalItemIdentification**

(CatalogueItemSpecificationUpdate.CatalogueItemSpecificationUpdateLine.Item.AdditionalItemIdentification) specification

Name	CatalogueItemSpecificationUpdate.CatalogueItemSpecificationUpdateLine.Item.AdditionalItemIdentification	Alternative term	
Definition	Information about Item identification		

Fields

UBL-Name	Name	Datatype	Usage	Cardinality
ID	ID	Identifier	Yes	1
ExtendedID	ExtendedID	Identifier	Yes	0..1

Subclasses in class AdditionalItemIdentification

(CatalogueItemSpecificationUpdate.CatalogueItemSpecificationUpdateLine.Item.AdditionalItemIdentification)

UBL-Name	Name	Usage	Cardinality	Reference
IssuerParty	IssuerParty	Bilateral	0..1	G30 3.70

Field specifications**ID**

Fieldname	ID	Alternative term	
Cardinality	1	Usage	Yes
Datatype	Identifier		
Definition	An identifier for an Item		

ExtendedID

Fieldname	ExtendedID	Alternative term	
Cardinality	0..1	Usage	Yes
Datatype	Identifier		
Definition	An extended identifier for the item which identifies the item with specific properties e.g. Item 123 = Chair / Item 123 Ext 45 = Brown chair		

Class Specification**IssuerParty**

Classname	IssuerParty	Alternative term	
Cardinality	0..1	Usage	Bilateral
Datatype	Party		
Definition	An association to Issuer Party i.e. the Party that issued the Item Identification		
See section	G30 3.70		

Excluded classes and fields in AdditionalItemIdentification

(CatalogueItemSpecificationUpdate.CatalogueItemSpecificationUpdateLine.Item.AdditionalItemIdentification)

Name	Name	Type
PhysicalAttribute	PhysicalAttribute	Class
MeasurementDimension	MeasurementDimension	Class

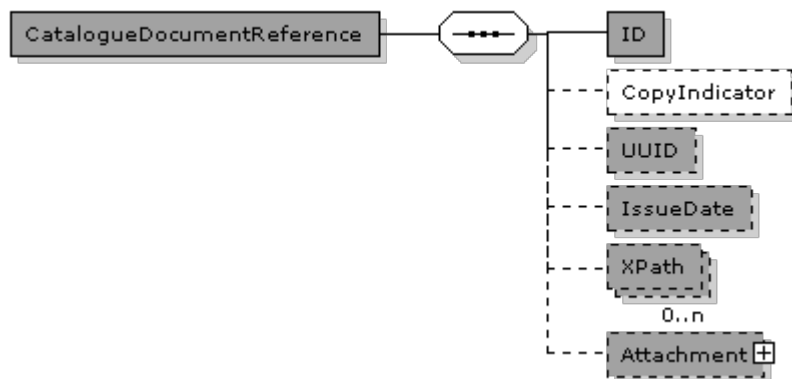
3.6.1.7.**CatalogueItemSpecificationUpdate.CatalogueItemSpecificationUpdateLine.Item.CatalogueDocumentReference****CatalogueDocumentReference****(CatalogueItemSpecificationUpdate.CatalogueItemSpecificationUpdateLine.Item.CatalogueDocumentReference) specification**

Name	CatalogueItemSpecificationUpdate.CatalogueItemSpecificationUpdateLine.Item.CatalogueDocumentReference	Alternative term	OIOUBL_GUIDE_DOCUMENTREF
Definition	Information about a Document referred to in another Document		
See also	OIOUBL_GUIDE_DOCUMENTREF (OIO)		

Fields

UBL-Name	Name	Datatype	Usage	Cardinality
ID	ID	Identifier	Yes	1
CopyIndicator	CopyIndicator	Indicator	Bilateral	0..1
UUID	UUID	Identifier	Yes	0..1
IssueDate	IssueDate	Date	Yes	0..1
XPath	XPath	Text	Yes	0..n

Subclasses in class CatalogueDocumentReference**(CatalogueItemSpecificationUpdate.CatalogueItemSpecificationUpdateLine.Item.CatalogueDocumentReference)**

UBL-Name	Name	Usage	Cardinality	Reference
Attachment	Attachment	Yes	0..1	3.6.1.7.1

Field specifications**ID**

Fieldname	ID	Alternative term	
Cardinality	1	Usage	Yes
Datatype	Identifier		
Definition	The identifier for the Document being referred to		
Example	428.34		

CopyIndicator

Fieldname	CopyIndicator	Alternative term	
Cardinality	0..1	Usage	Bilateral
Datatype	Indicator		
Definition	Indicates whether the referenced Document is a copy (true) or the original (false)		
Example	false		

UUID

Fieldname	UUID	Alternative term	OIOUBL_GUIDE_UUID
Cardinality	0..1	Usage	Yes
Datatype	Identifier		
Definition	A computer-generated universally unique identifier (UUID) for the referenced Document instance		
See also	OIOUBL_GUIDE_UUID (G32)		

IssueDate

Fieldname	IssueDate	Alternative term	
Cardinality	0..1	Usage	Yes
Datatype	Date		
Definition	The date assigned by the sender of the referenced Document on which the referenced Document was issued		
Example	2006-09-01		

XPath

Fieldname	XPath	Alternative term	
Cardinality	0..n	Usage	Yes
Datatype	Text		
Definition	Refers to another part of the same document instance		
Example	/DocumentReference[ID='428.22']		

Class Specification**Attachment**

Classname	Attachment	Alternative term	
Cardinality	0..1	Usage	Yes
Datatype	Attachment		
Definition	An attached document, external referred to, referred in the MIME location or embedded.		
See section	3.6.1.7.1		

Excluded classes and fields in CatalogueDocumentReference

(CatalogueItemSpecificationUpdate.CatalogueItemSpecificationUpdateLine.Item.CatalogueDocumentReference)

Name	Name	Type
DocumentTypeCode	DocumentTypeCode	Field
DocumentType	DocumentType	Field

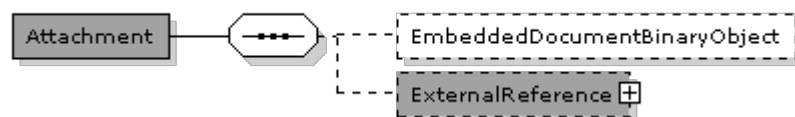
3.6.1.7.1.**CatalogueItemSpecificationUpdate.CatalogueItemSpecificationUpdateLine.Item.CatalogueDocumentReference.Attachment****Attachment****(CatalogueItemSpecificationUpdate.CatalogueItemSpecificationUpdateLine.Item.CatalogueDocumentReference.Attachment) specification**

Name	CatalogueItemSpecificationUpdate.CatalogueItemSpecificationUpdateLine.Item.CatalogueDocumentReference.Attachment	Alternative term	OIOUBL_GUIDE_ATTACHMENT
Definition	Information about an attached document. An attachment can be referred to externally (with the URI element), internally (with the MIME reference element) or contained within the document itself (with the EmbeddedDocument element).		
See also	OIOUBL_GUIDE_ATTACHMENT (OIO)		

Fields

UBL-Name	Name	Datatype	Usage	Cardinality
EmbeddedDocumentBinaryObject	EmbeddedDocumentBinaryObject	Binary Object	Bilateral	0..1

Subclasses in class Attachment**(CatalogueItemSpecificationUpdate.CatalogueItemSpecificationUpdateLine.Item.CatalogueDocumentReference.Attachment)**

UBL-Name	Name	Usage	Cardinality	Reference
ExternalReference	ExternalReference	Yes	0..1	G30 3.41

CatalogueItemSpecificationUpdate.CatalogueItemSpecificationUpdateLine.Item.CatalogueDocumentReference.Attachment

Field specifications

EmbeddedDocumentBinaryObject

Fieldname	EmbeddedDocumentBinaryObject	Alternative term	
Cardinality	0..1	Usage	Bilateral
Datatype	Binary Object		
Definition	Contains an embedded document as a BLOB,		
Businessrules	Only allowed if no ExternalReference is specified and if bilateral agreed.		
Dependency	../ExternalReference		

Class Specification

ExternalReference

Classname	ExternalReference	Alternative term	
Cardinality	0..1	Usage	Yes
Datatype	ExternalReference		
Definition	An attached document, external referred to, referred in the MIME location or embedded.		
Businessrules	Used if no EmbeddedDocumentBinaryObject specified		
Dependency	../EmbeddedDocumentBinaryObject		
See section	G30 3.41		

Excluded classes and fields in Attachment

(CatalogueItemSpecificationUpdate.CatalogueItemSpecificationUpdateLine.Item.CatalogueDocumentReference.Attachment)

None

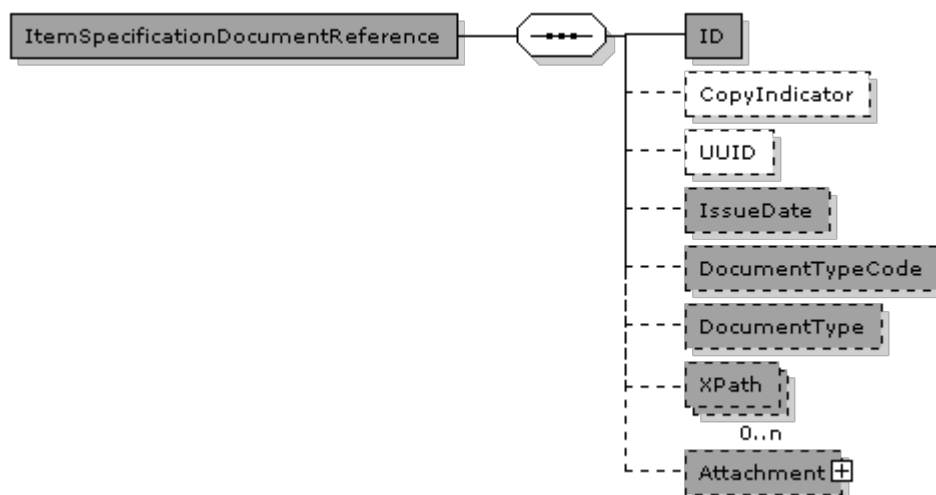
3.6.1.8.**CatalogueItemSpecificationUpdate.CatalogueItemSpecificationUpdateLine.Item.ItemSpecificationDocumentReference****ItemSpecificationDocumentReference**

(CatalogueItemSpecificationUpdate.CatalogueItemSpecificationUpdateLine.Item.ItemSpecificationDocumentReference) specification

Name	CatalogueItemSpecificationUpdate.CatalogueItemSpecificationUpdateLine.Item.ItemSpecificationDocumentReference	Alternative term	
Definition	Information about a document referred to in another document		

Fields

UBL-Name	Name	Datatype	Usage	Cardinality
ID	ID	Identifier	Yes	1
CopyIndicator	CopyIndicator	Indicator	Bilateral	0..1
UUID	UUID	Identifier	Bilateral	0..1
IssueDate	IssueDate	Date	Yes	0..1
DocumentTypeCode	DocumentTypeCode	Code	Yes	0..1
DocumentType	DocumentType	Text	Yes	0..1
XPath	XPath	Text	Yes	0..n

Subclasses in class ItemSpecificationDocumentReference

(CatalogueItemSpecificationUpdate.CatalogueItemSpecificationUpdateLine.Item.ItemSpecificationDocumentReference)

UBL-Name	Name	Usage	Cardinality	Reference
Attachment	Attachment	Yes	0..1	G30 3.5

Field specifications**ID**

Fieldname	ID	Alternative term	
Cardinality	1	Usage	Yes
Datatype	Identifier		
Definition	Identification for the document being referred to		

CopyIndicator

Fieldname	CopyIndicator	Alternative term	
Cardinality	0..1	Usage	Bilateral
Datatype	Indicator		
Definition	Specifies if the referred document is a copy (true) or the original (false)		

UUID

Fieldname	UUID	Alternative term	
Cardinality	0..1	Usage	Bilateral
Datatype	Identifier		
Definition	Computer-generated universally unique ID (UUID) for the document instance being referred to		

IssueDate

Fieldname	IssueDate	Alternative term	
Cardinality	0..1	Usage	Yes
Datatype	Date		
Definition	The issue date for the reference document specified by the sender of the reference document		

DocumentTypeCode

Fieldname	DocumentTypeCode	Alternative term	
Cardinality	0..1	Usage	Yes
Datatype	Code		
Definition	The document type specified as a code		
Businessrules	Mandatory if DocumentType is not specified.		
Codelist	urn:oiubl:codelist:cataloguedocumenttypecode-1.1		

DocumentType

Fieldname	DocumentType	Alternative term	
Cardinality	0..1	Usage	Yes
Datatype	Text		
Definition	The document type specified as a text		
Businessrules	Mandatory if DocumentTypecode is not specified.		

XPath

Fieldname	XPath	Alternative term	
Cardinality	0..n	Usage	Yes
Datatype	Text		
Definition	Refers to another part of the same document instance		
Businessrules	Can only be used if there are no Attached documents		
Dependency	../Attachment		

Class Specification**Attachment**

CatalogueItemSpecificationUpdate.CatalogueItemSpecificationUpdateLine.Item.ItemSpecificationDocumentReference

Classname	Attachment	Alternative term	
Cardinality	0..1	Usage	Yes
Datatype	Attachment		
Definition	An externally referred attachment, referred on the MIME-location or embedded		
Businessrules	Can only be used if no XPath is specified		
Dependency	../XPath		
See section	G30 3.5		

**Excluded classes and fields in ItemSpecificationDocumentReference
(CatalogueItemSpecificationUpdate.CatalogueItemSpecificationUpdateLine.Item.ItemSpecificationDocumentReference)**

None

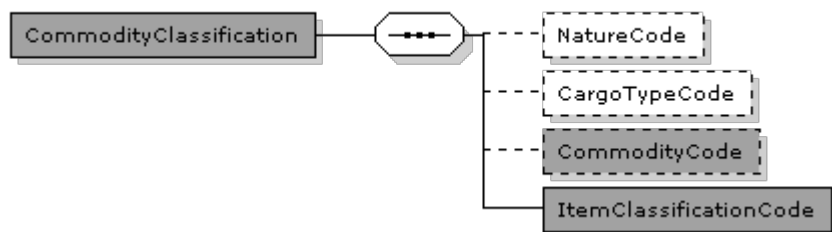
3.6.1.9.**CatalogueItemSpecificationUpdate.CatalogueItemSpecificationUpdateLine.Item.CommodityClassification****CommodityClassification****(CatalogueItemSpecificationUpdate.CatalogueItemSpecificationUpdateLine.Item.CommodityClassification) specification**

Name	CatalogueItemSpecificationUpdate.CatalogueItemSpecificationUpdateLine.Item.CommodityClassification	Alternative term	
Definition	Information about Commodity Classification		

Fields

UBL-Name	Name	Datatype	Usage	Cardinality
NatureCode	NatureCode	Code	Bilateral	0..1
CargoTypeCode	CargoTypeCode	Code	Bilateral	0..1
CommodityCode	CommodityCode	Code	Yes	0..1
ItemClassificationCode	ItemClassificationCode	Code	Yes	1

Subclasses in class CommodityClassification**(CatalogueItemSpecificationUpdate.CatalogueItemSpecificationUpdateLine.Item.CommodityClassification)**

None

Field specifications**NatureCode**

Fieldname	NatureCode	Alternative term	
Cardinality	0..1	Usage	Bilateral
Datatype	Code		
Definition	The high level nature of Classification issued by a specific maintenance agency expressed as a code		

CargoTypeCode

Fieldname	CargoTypeCode	Alternative term	
Cardinality	0..1	Usage	Bilateral
Datatype	Code		
Definition	The type of cargo expressed as a code		

CommodityCode

Fieldname	CommodityCode	Alternative term	
Cardinality	0..1	Usage	Yes
Datatype	Code		
Definition	The harmonized international commodity code for regulatory (customs and trade statistics) purposes.		

ItemClassificationCode

Fieldname	ItemClassificationCode	Alternative term	
Cardinality	1	Usage	Yes
Datatype	Code		
Definition	The trade commodity classification expressed as a code		
Businessrules	The same classification must be used for all the Items in a document.		
Recommendation	UNSPSC version 7.0401 is recommended. For latest version see http://www.gs1.dk/unspscdk3 .		

Excluded classes and fields in CommodityClassification
(CatalogueItemSpecificationUpdate.CatalogueItemSpecificationUpdateLine.Item.CommodityClassification)

None

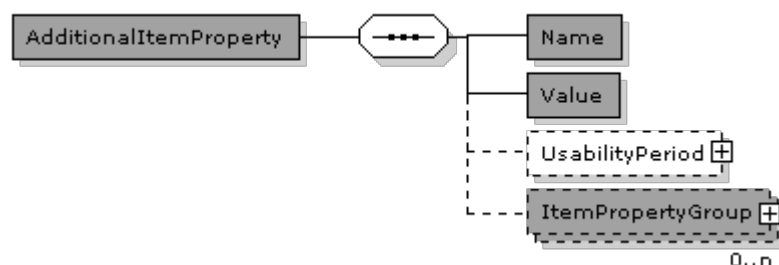
3.6.1.10.**CatalogueItemSpecificationUpdate.CatalogueItemSpecificationUpdateLine.Item.AdditionalItemProperty****AdditionalItemProperty**

(CatalogueItemSpecificationUpdate.CatalogueItemSpecificationUpdateLine.Item.AdditionalItemProperty) specification

Name	CatalogueItemSpecificationUpdate.CatalogueItemSpecificationUpdateLine.Item.AdditionalItemProperty	Alternative term	
Definition	Information about specific ItemProperties.		

Fields

UBL-Name	Name	Datatype	Usage	Cardinality
Name	Name	Name	Yes	1
Value	Value	Text	Yes	1

Subclasses in class AdditionalItemProperty

(CatalogueItemSpecificationUpdate.CatalogueItemSpecificationUpdateLine.Item.AdditionalItemProperty)

UBL-Name	Name	Usage	Cardinality	Reference
UsabilityPeriod	UsabilityPeriod	Bilateral	0..1	G30 3.78
ItemPropertyGroup	ItemPropertyGroup	Yes	0..n	3.6.1.10.1

Field specifications**Name**

Fieldname	Name	Alternative term	
Cardinality	1	Usage	Yes
Datatype	Name		
Definition	The Name of the ItemProperty		
Example	Size, Year		

Value

Fieldname	Value	Alternative term	
Cardinality	1	Usage	Yes
Datatype	Text		
Definition	The value of the ItemProperty		
Example	XS, 2006		

Class Specification**UsabilityPeriod**

Classname	UsabilityPeriod	Alternative term	
Cardinality	0..1	Usage	Bilateral
Datatype	Period		
Definition	The period in which the ItemProperty is valid		
See section	G30 3.78		

ItemPropertyGroup

Classname	ItemPropertyGroup	Alternative term	
Cardinality	0..n	Usage	Yes
Datatype	ItemPropertyGroup		
Definition	Information about ItemPropertyGroup		
Businessrules	Used to specify if a AdditionalItemProperty (attribute) is common or specific to a category. If not specified the attribute is considered common		
See section	3.6.1.10.1		

**Excluded classes and fields in AdditionalItemProperty
(CatalogueItemSpecificationUpdate.CatalogueItemSpecificationUpdateLine.Item.AdditionalItemProperty)**

None

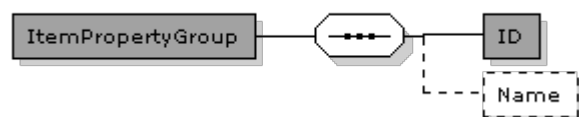
3.6.1.10.1.***CatalogueItemSpecificationUpdate.CatalogueItemSpecificationUpdateLine.Item.AdditionalItemProperty.ItemPropertyGroup*****ItemPropertyGroup****(CatalogueItemSpecificationUpdate.CatalogueItemSpecificationUpdateLine.Item.AdditionalItemProperty.ItemPropertyGroup) specification**

Name	CatalogueItemSpecificationUpdate.CatalogueItemSpecificationUpdateLine.Item.AdditionalItemProperty.ItemPropertyGroup	Alternative term	
Definition	Information about classifications (or groups) of ItemProperties		

Fields

UBL-Name	Name	Datatype	Usage	Cardinality
ID	ID	Identifier	Yes	1
Name	Name	Name	Bilateral	0..1

Subclasses in class ItemPropertyGroup**(CatalogueItemSpecificationUpdate.CatalogueItemSpecificationUpdateLine.Item.AdditionalItemProperty.ItemPropertyGroup)**

None

CatalogueItemSpecificationUpdate.CatalogueItemSpecificationUpdateLine.Item.AdditionalItemProperty.ItemPropertyGroup

Field specifications

ID

Fieldname	ID	Alternative term	
Cardinality	1	Usage	Yes
Datatype	Identifier		
Definition	An identification for ItemPropertyGroup		
Businessrules	If the attribute is common to all products the value should be ROOT. If the attribute only applies to a distinct category, the value must be the category ID e.g. a UNSPSC code. The ID attributes can be used to specify the type of ID e.g. schemeName="UNSPSC", schemeVersionID="7.0401" etc.		
Example	ROOT, 50202203		

Name

Fieldname	Name	Alternative term	
Cardinality	0..1	Usage	Bilateral
Datatype	Name		
Definition	The Name of the ItemPropertyGroup		
Example	Wine		

Excluded classes and fields in ItemPropertyGroup (CatalogueItemSpecificationUpdate.CatalogueItemSpecificationUpdateLine.Item.AdditionalItemProperty.ItemPropertyGroup)

None